

# MULTIPLE CONVOLUTION BELLOWS

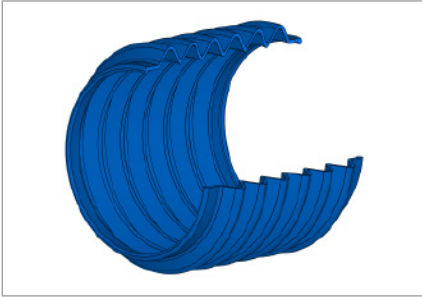

## PRODUCT DESCRIPTION

Bellows are protective elements comprising a moving section and two connection pieces for fastening. They protect axially moving rods and parts of machines against soiling, water spray, dust or the effects of the weather. Depending on their design, they can accommodate movements perpendicular to the axis or a combination of movements (e.g. gear levers).

Bellows are able to follow axial movements within their limits  $L_{\min}$  (compressed length) and  $L_{\max}$  (extended length). Special loads (non-axial movements, pressure loads etc.) affect the maximum working stroke and the flexibility → Technical Manual.

## PRODUCT ADVANTAGES

Depending on the application, bellows and connecting areas can have very different geometrical shapes and dimensions. More than 500 different bellows geometries are available to the user quickly and cost-effectively.

## APPLICATION

There are many application cases for bellows, for example, the functional sealing of ball joints, connection of two tube ends, push rods (e.g. in hydraulic and pneumatic applications), axle bearings.

## MATERIAL

Material	Hardness
CR	42/50 Shore A
NBR	approx. 45 Shore A

Other materials on enquiry (after clarification of the material-job specification and the type).

## OPERATING CONDITIONS

Material	Temperature	Dynamic loading	Mineral oil and grease resistance
CR	-40 ... +100 °C	very good	sufficient
NBR	-30 ... +100 °C	sufficient	good

The values listed in the table are recommended values.  
→ Technical Manual.

## FITTING & INSTALLATION

The moving section of the bellows must not come into contact with any sharp edges. It is imperative that continuous chaffing against moving parts of the machine is avoided.

Bellows are not able to absorb major excess pressure or vacuum, as otherwise excessive deformation would occur.

To prevent a pressure build-up inside bellows on axial movements, a sufficient ventilation must be provided.

Torsional loading of the bellows should be avoided.

For further information on installation: → Technical Manual.

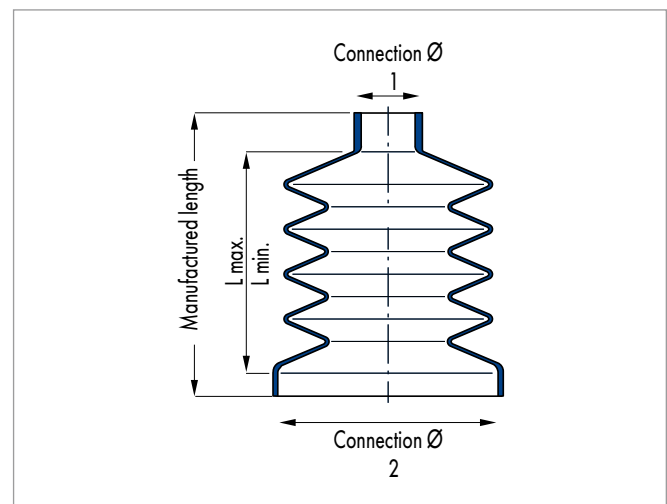

Drawing with dimensions multiple convolution bellows

## MODULAR TPE BELLOWS

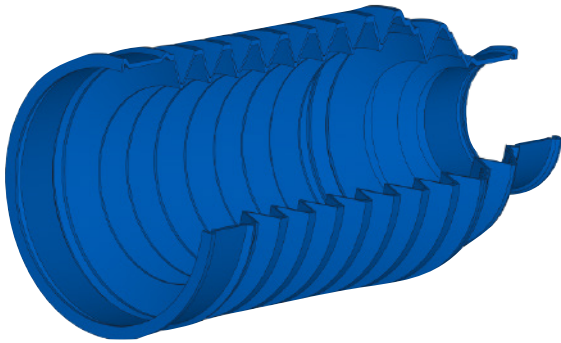

### PRODUCT DESCRIPTION

Modular TPE bellows constitute one part of the FST catalog portfolio. These are multi-convolution bellows made of thermoplastic elastomer, which are constructed according to the toolbox principle. The bellows can be varied in the manufacturing length (85 to 200 mm), the outside diameters (in gradations of Ø50, Ø63, Ø80, Ø100 and Ø125) and the connection areas by using different mold inserts and can thus be adapted precisely to the customer's application. Deviating manufacturing lengths and finer gradations of the outside diameters are possible on request.

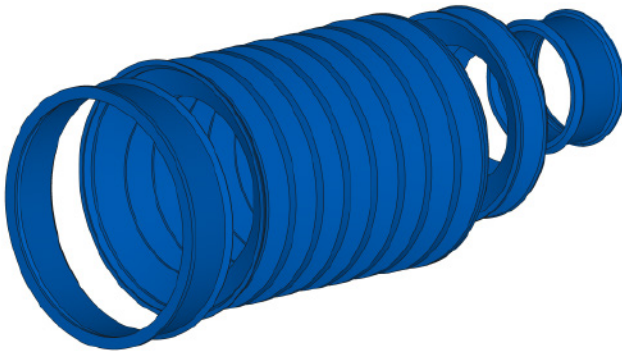

Example illustration of a modular TPE bellows

### PRODUCT ADVANTAGES

The customer is given the opportunity to create the desired bellows that fit precisely by choosing the right dimensions with our modular tool concept. Connections, convolution area and length are individually selectable, enabling a wide range of applications.

The depth and width of the convolutions and the connection areas are designed by Freudenberg depending on the customer's specifications for the application.

Due to the modular tool concept, different solutions can be realized and allow cost savings for follow-up projects of the customer.

The technical advantages of TPE compared to elastomer bellows lie primarily in its increased service life and ozone resistance.

### APPLICATION

- cardan joints
- piston rods
- joy sticks
- connection of pipe ends to compensate for backlash
- overrun brakes of trailers

### MATERIAL

Material	Temperature	Ozone resistance	Chemical resistance
Thermoplastic elastomer (TPE)	-40 ... +120 °C	high	as usual for polyolefins/thermo-plastics

The values listed in the table are approximate values. For more information please refer to the FST technical manual.

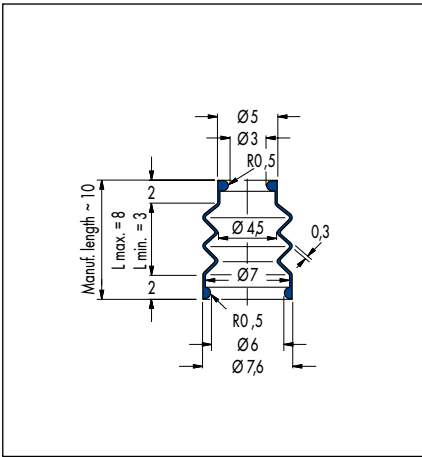

V6-00748, Article No. 29944

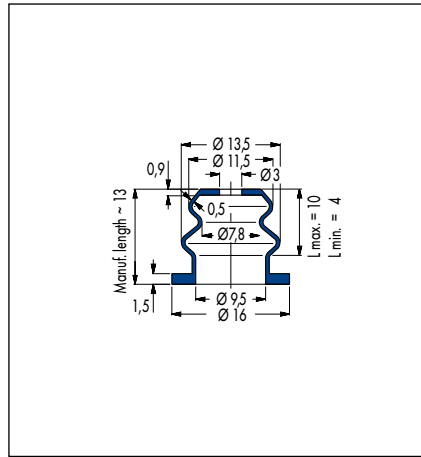

V6-00618, Article No. 49345230

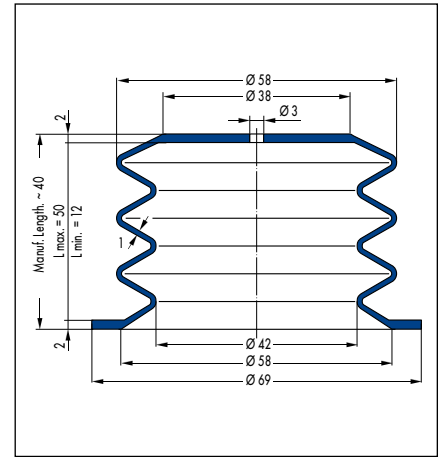

V6-00735, Article No. 456487

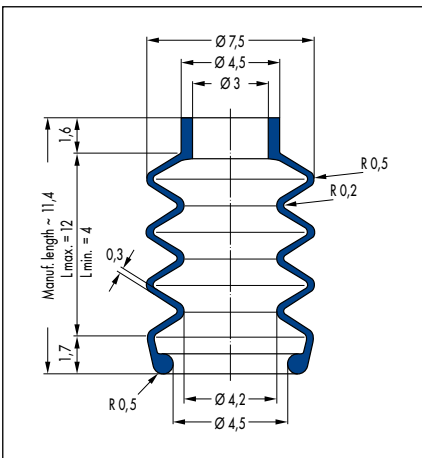

V6-01109, Article No. 5417

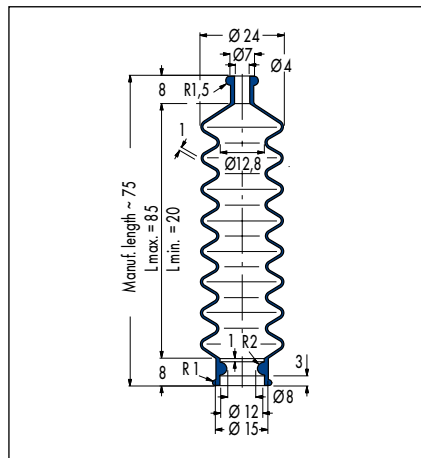

V6-00249, Article No. 438531 (42 CR 764)/  
327194 (56 CR 886)

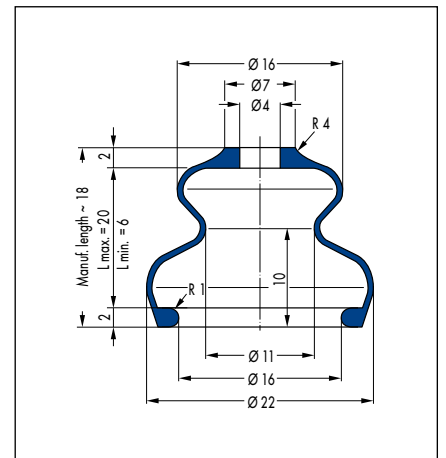

V6-01231, Article No. 8934

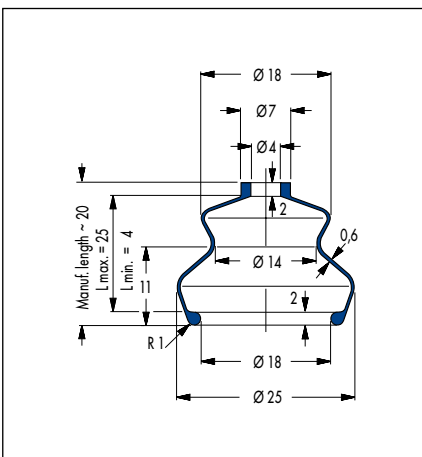

V6-00949, Article No. 435 (CR)/  
49028924 (NBR)

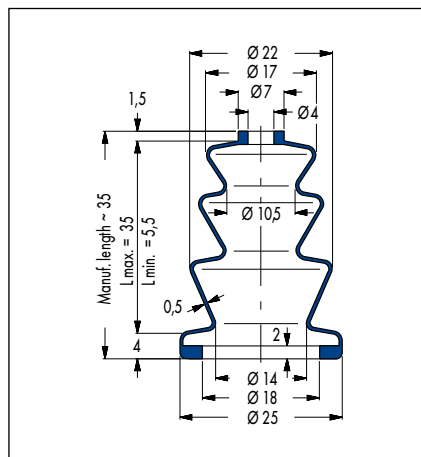

V6-01008, Article No. 14405

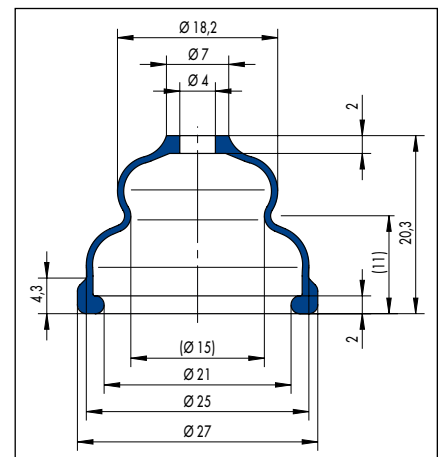

V6-20300, Article No. 49469789

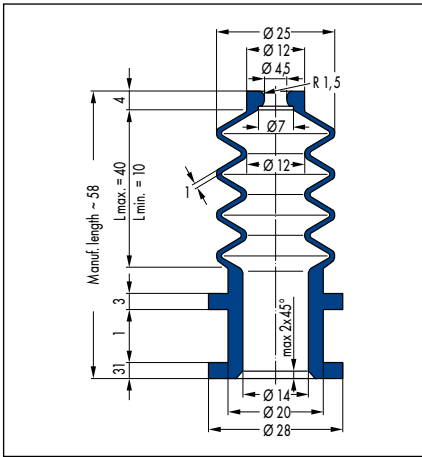

V6-01281, Article No. 389744

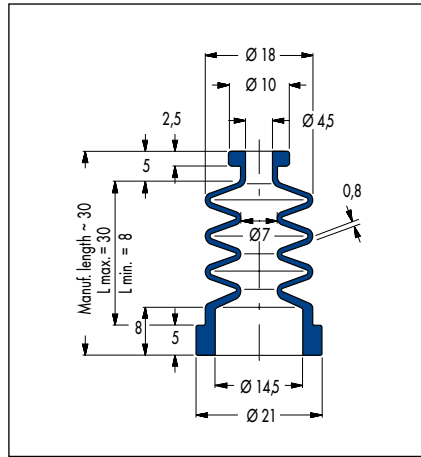

V6-00055, Article No. 29209

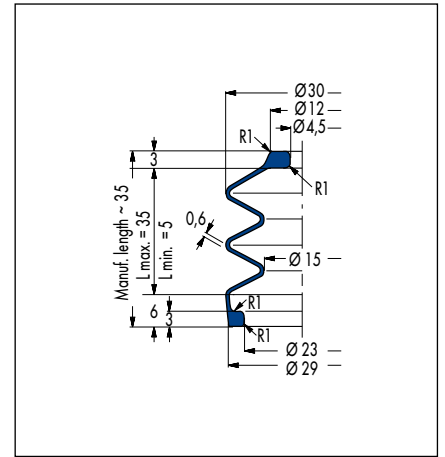

V6-00994, Article No. 49332674

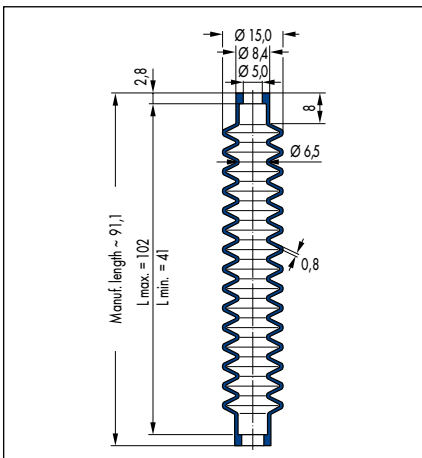

V6-20138, Article No. 420271

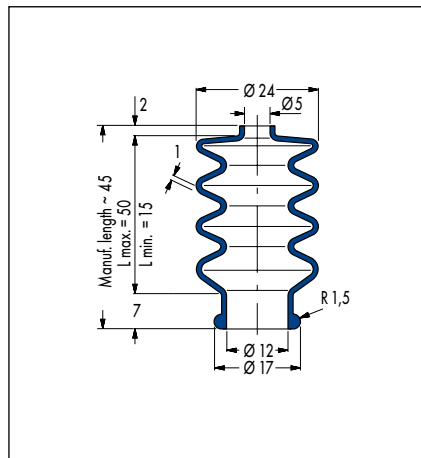

V6-00258, Article No. 438028

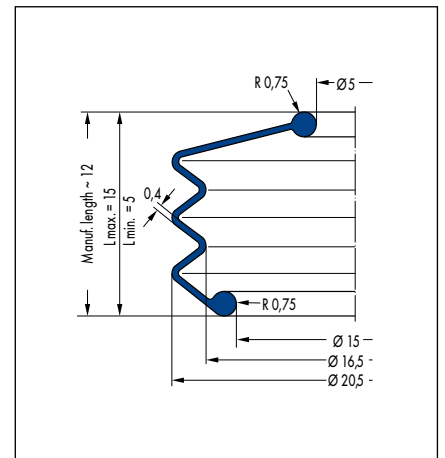

V6-01207, Article No. 452568

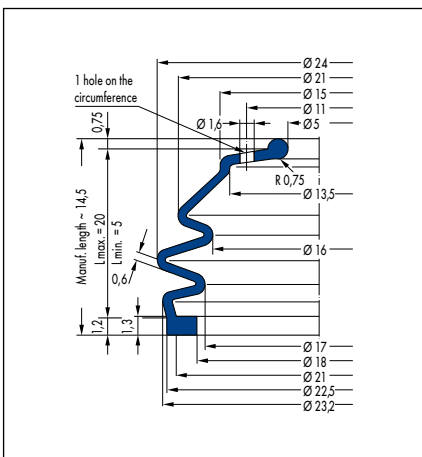

V6-01194, Article No. 440258

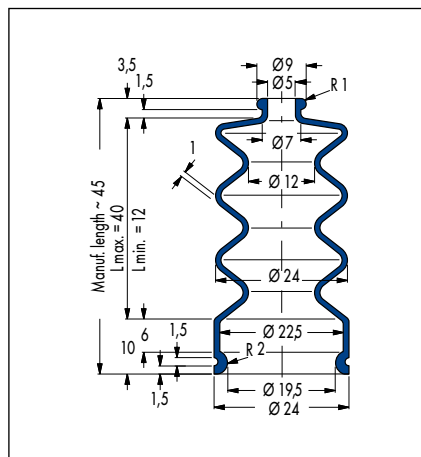

V6-00358, Article No. 435291

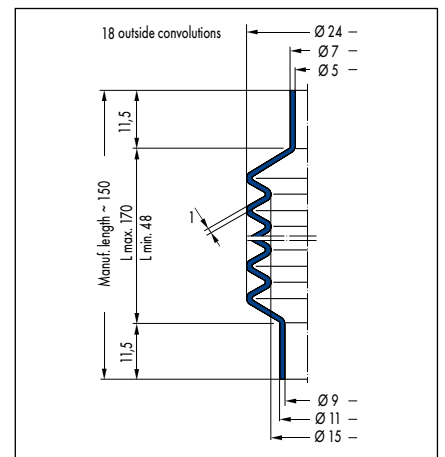

V6-00931, on request

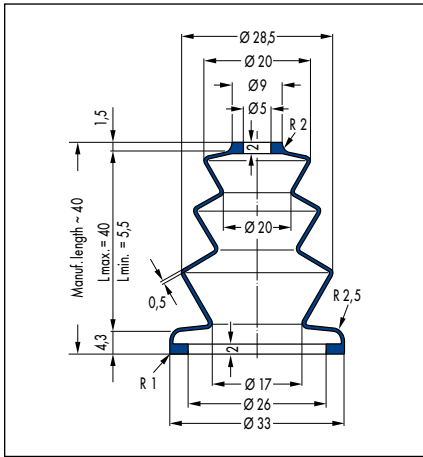

V6-01009, Article No. 456494

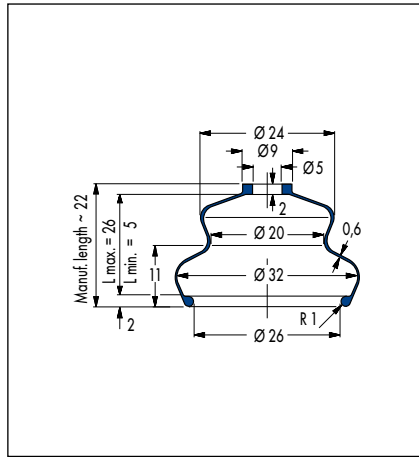

V6-00948, Article No. 434 (42 CR 764)/  
420983 (50 CR 879)

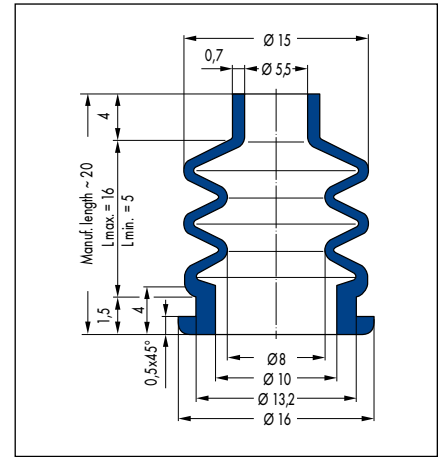

V6-20104, Article No. 400549

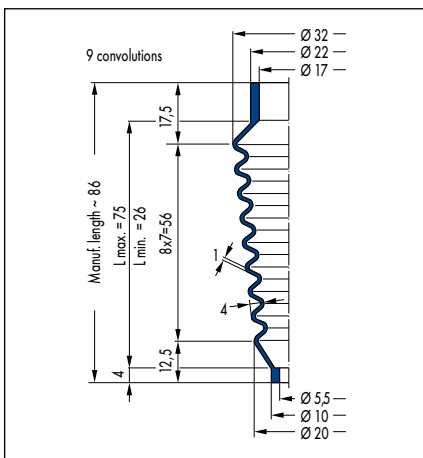

V6-01466, Article No. 457512

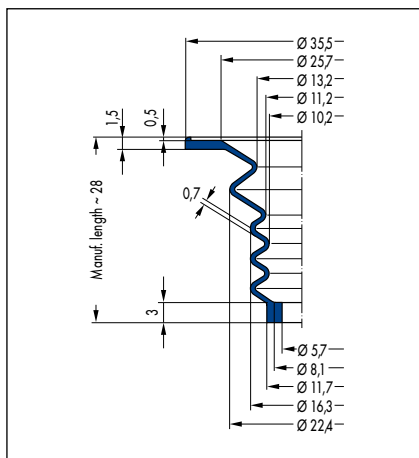

V6-01526, Article No. 400999 (CR)/  
152955 (NBR)

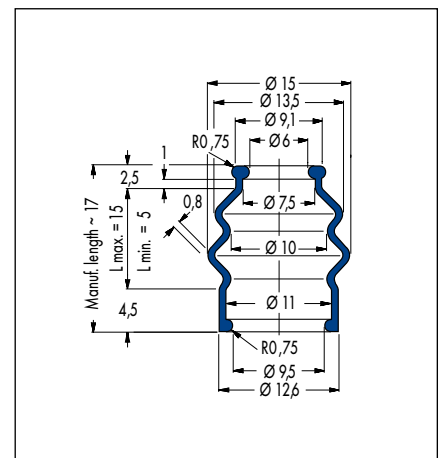

V6-00752, Article No. 428864

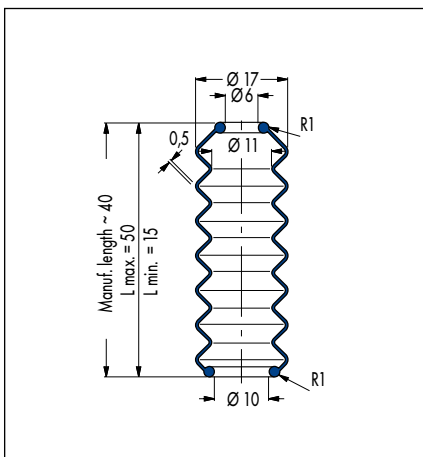

V6-00169, Article No. 438526

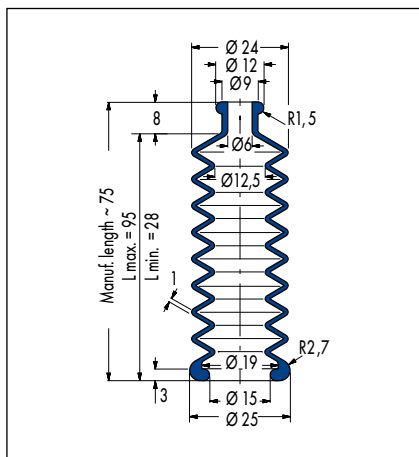

V6-00126, Article No. 435526

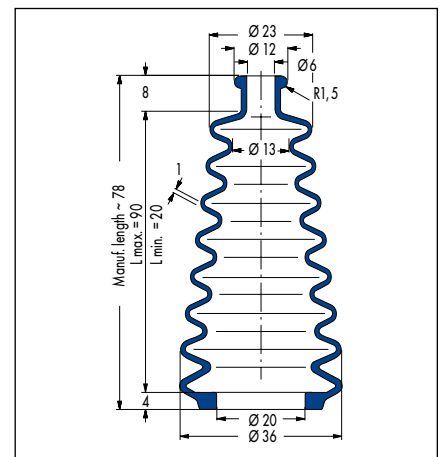

V6-00167, Article No. 438520

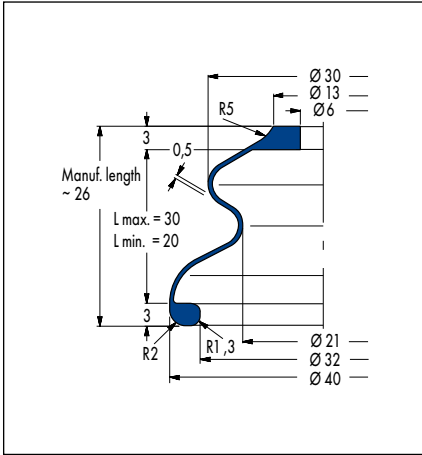

V6-01104, Article No. 434028

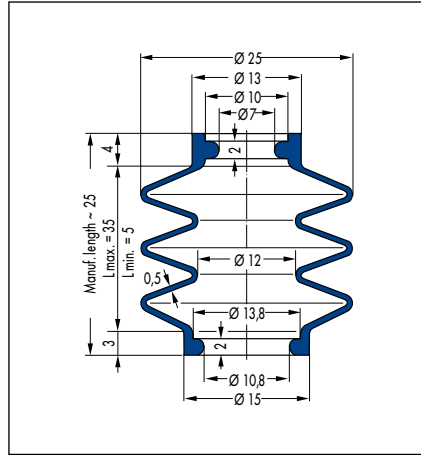

V6-00471, Article No. 507077

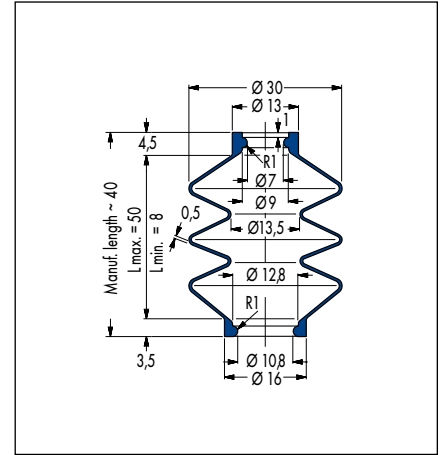

V6-00525, Article No. 438219 (45 NBR 670)/  
438221 (42 CR 764)

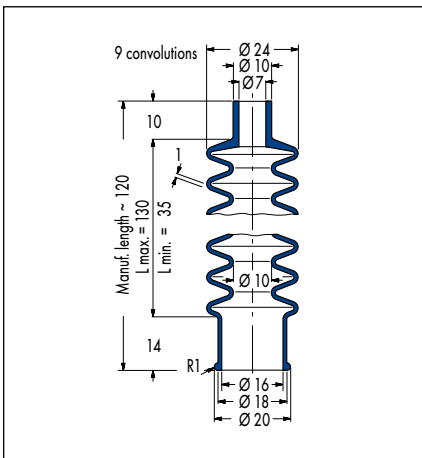

V6-00269, Article No. 438534

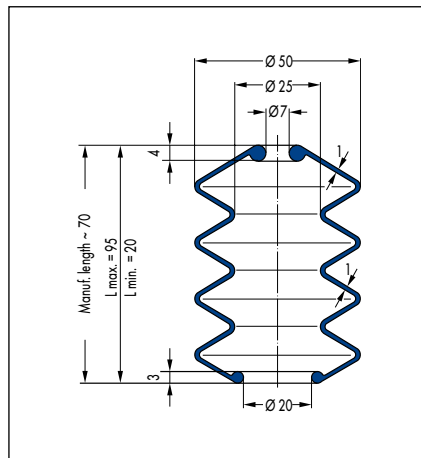

V6-01150, Article No. 142815

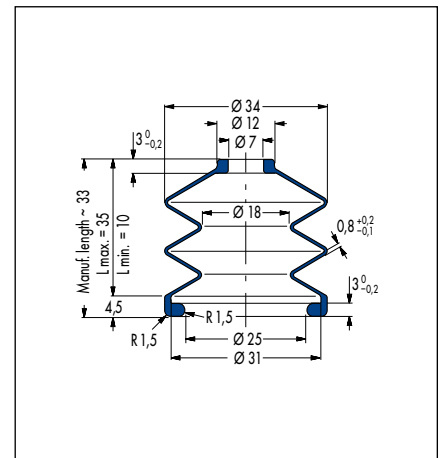

V6-00875, Article No. 5530

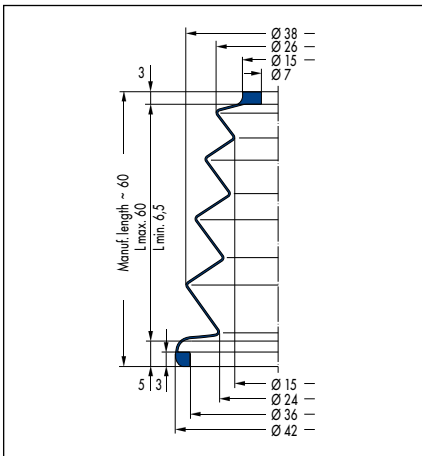

V6-01011, Article No. 400903

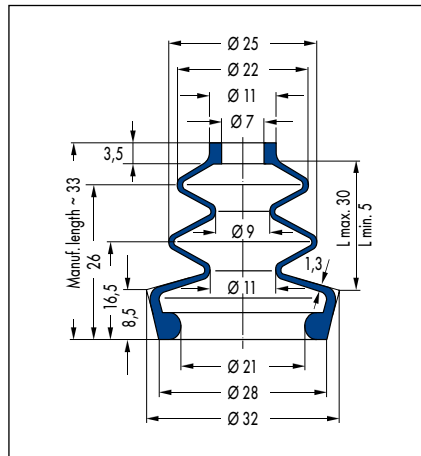

V6-01032, Article No. 402606

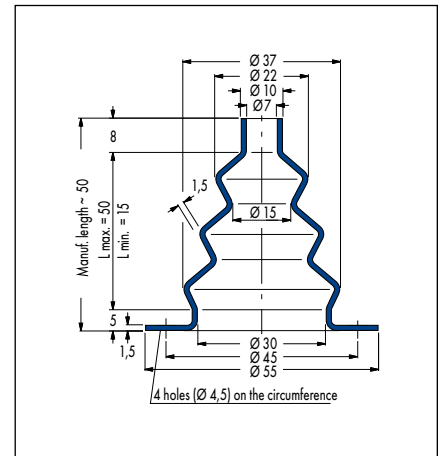

V6-00795, Article No. 451753

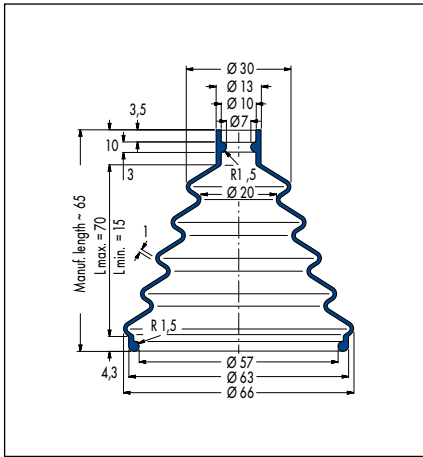

V6-00600, Article No. 438545

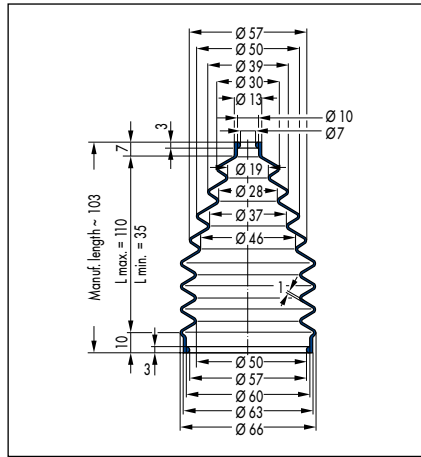

V6-20122, Article No. 452810

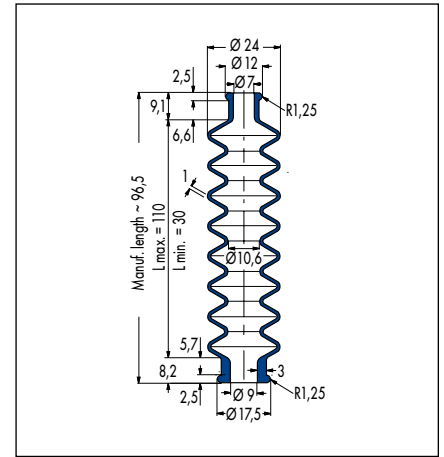

V6-00514, Article No. 49361113

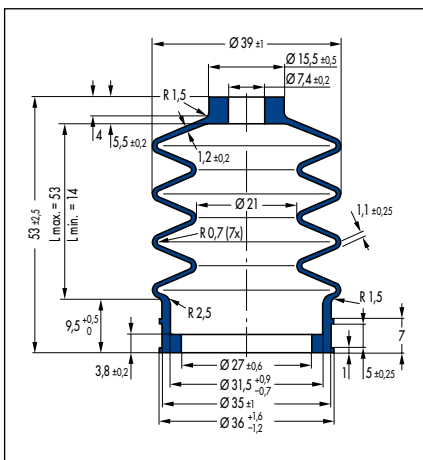

V6-01770, Article No. 49332698

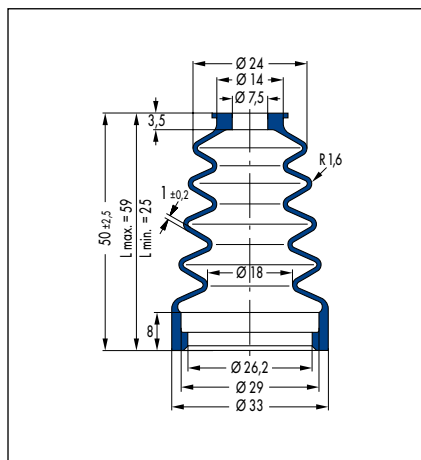

V6-01791, Article No. 49332670

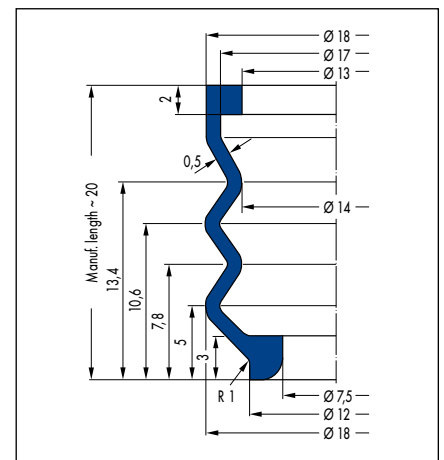

V6-01408, Article No. 400989

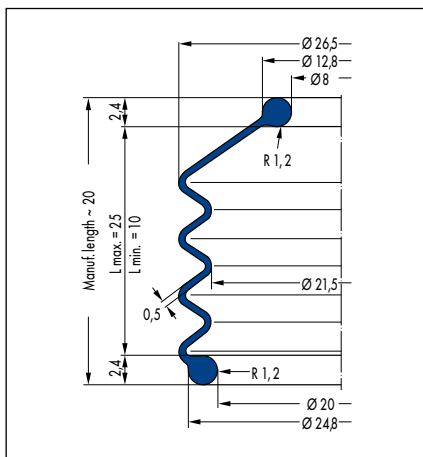

V6-01052, Article No. 81226

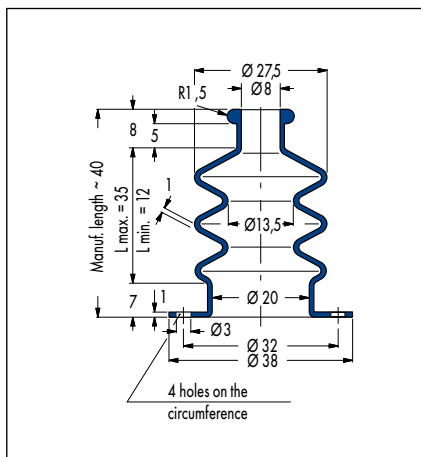

V6-00307, Article No. 29502

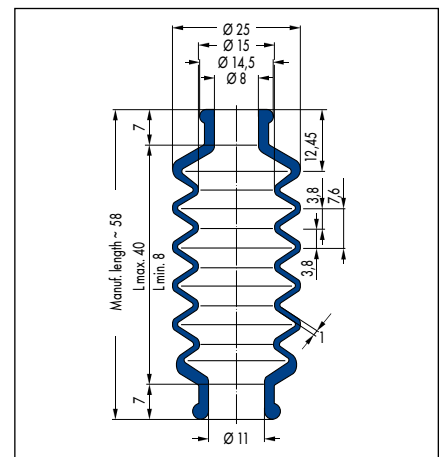

V6-00257, Article No. 439218

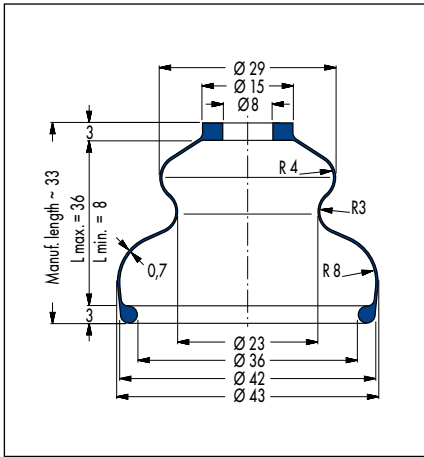

V6-00947, Article No. 436933

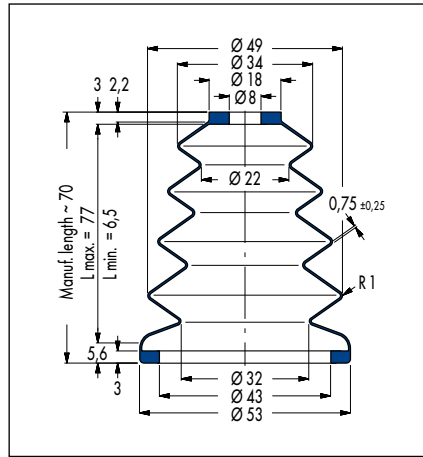

V6-01012, Article No. 453786

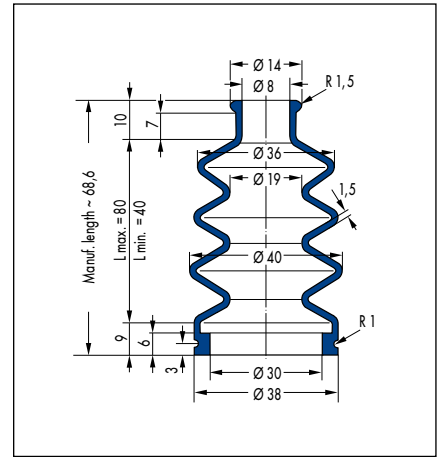

V6-01722, Article No. 49322415

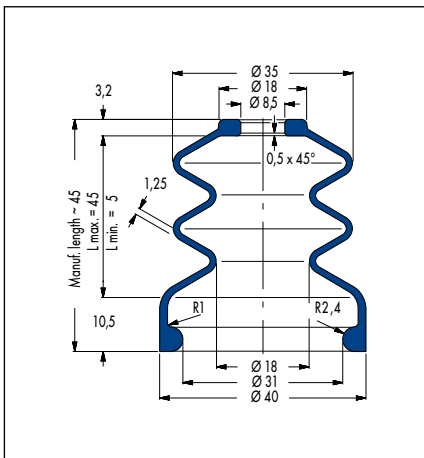

V6-01138, Article No. 428843

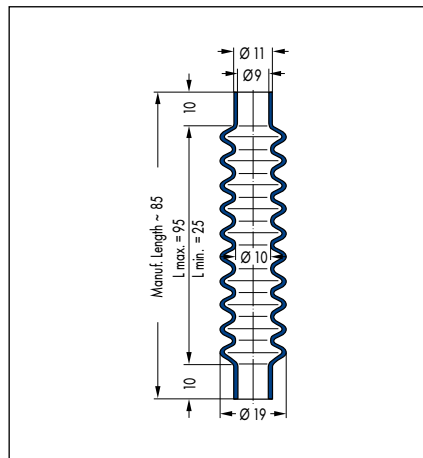

V6-00338, Article No. 439491

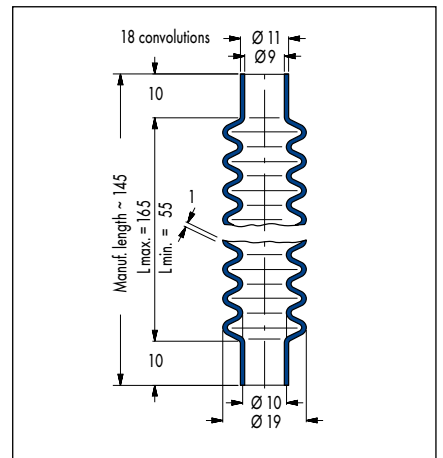

V6-00337, Article No. 439492

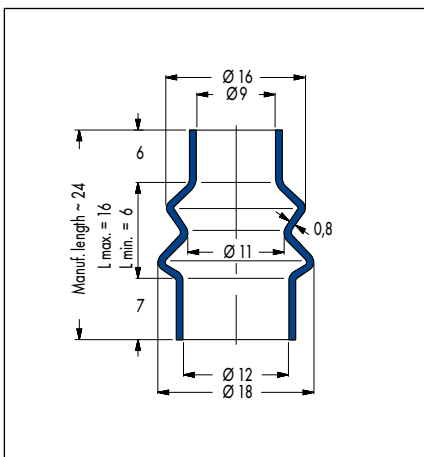

V6-00336, Article No. 439483

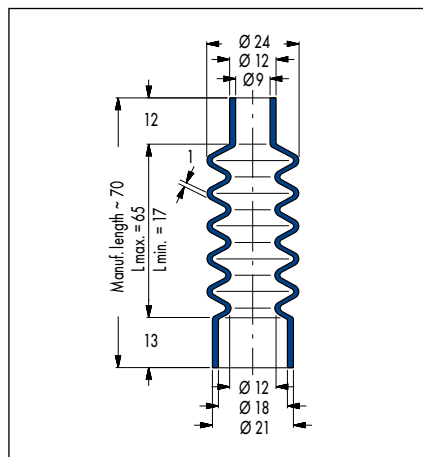

V6-00225, Article No. 428314

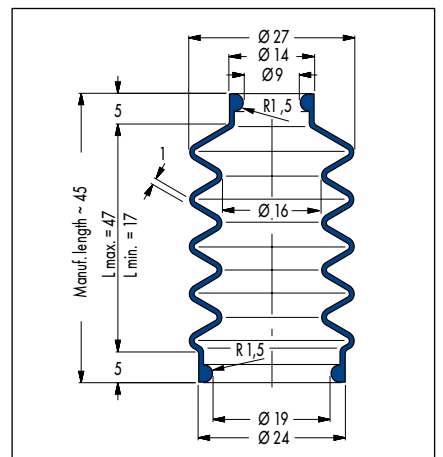

V6-00724, Article No. 438552



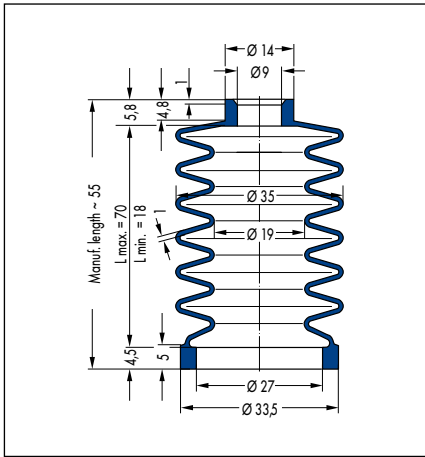

V6-00261, Article No. 439215

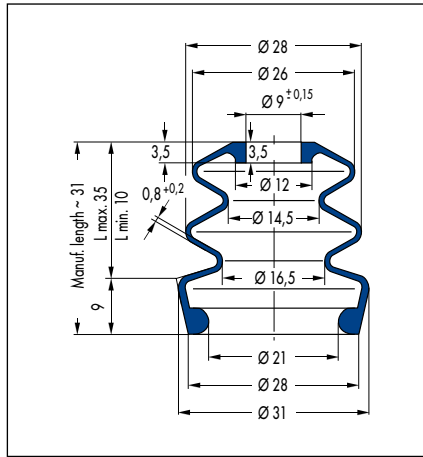

V6-00914, Article No. 400890

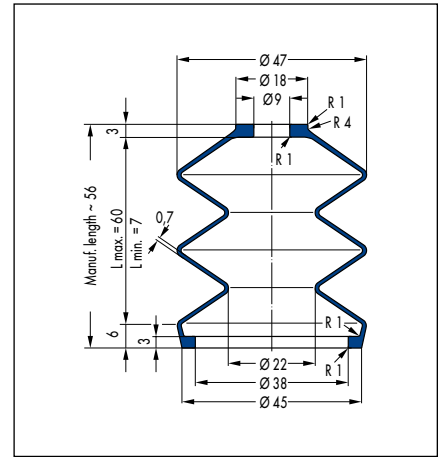

V6-00996, Article No. 457508

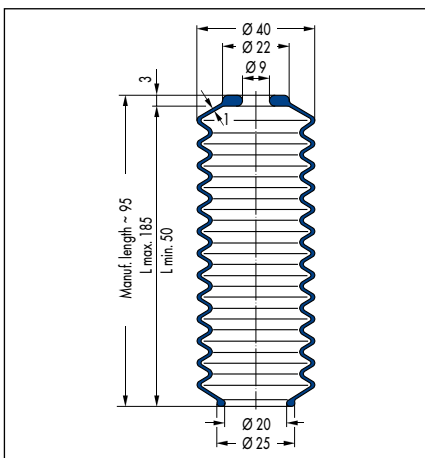

V6-00898, Article No. 400886

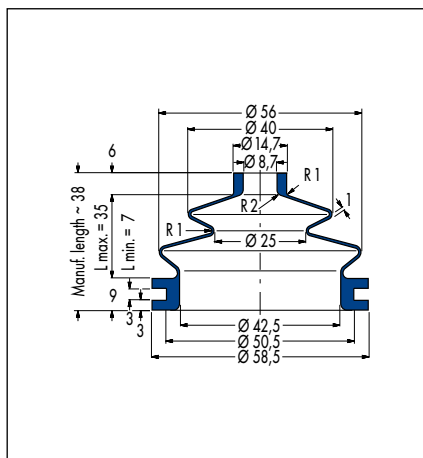

V6-00800, Article No. 435516

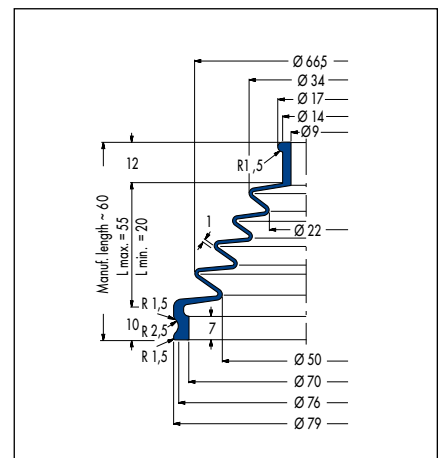

V6-00729, Article No. 49312520

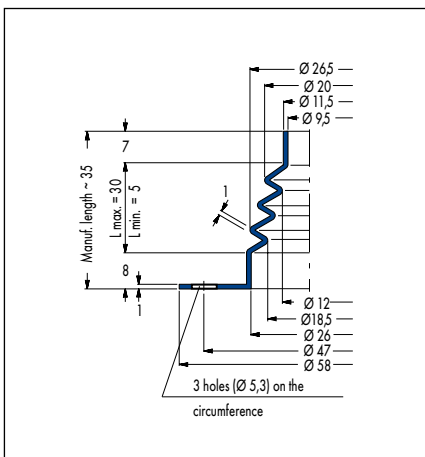

V6-00665, Article No. 426800

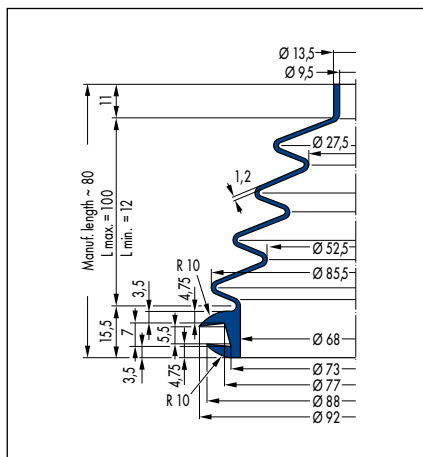

V6-00764, Article No. 380287

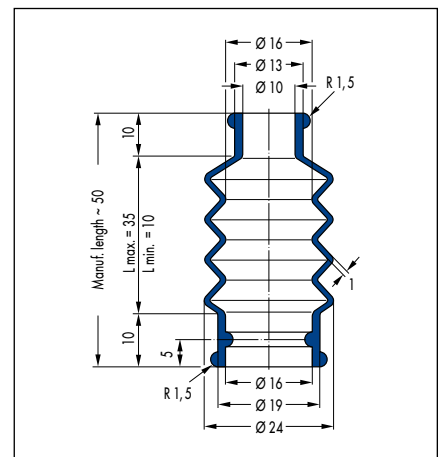

V6-01745, Article No. 436919

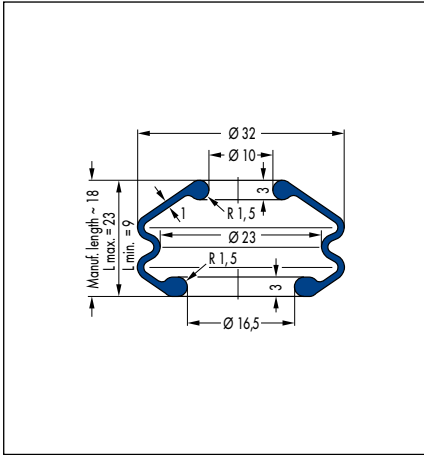

V6-00438, Article No. 29634

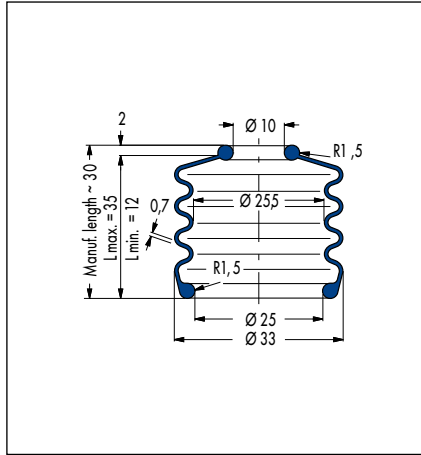

V6-00554, Article No. 438537

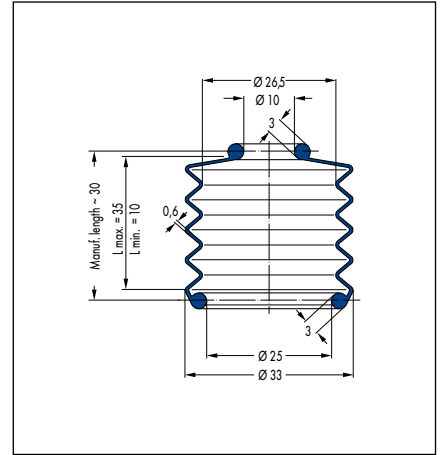

V6-00979, Article No. 5810

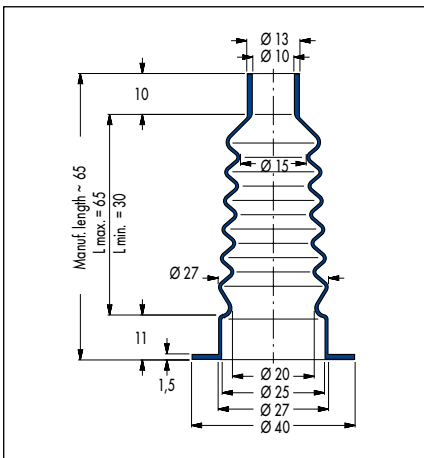

V6-00052, Article No. 432593

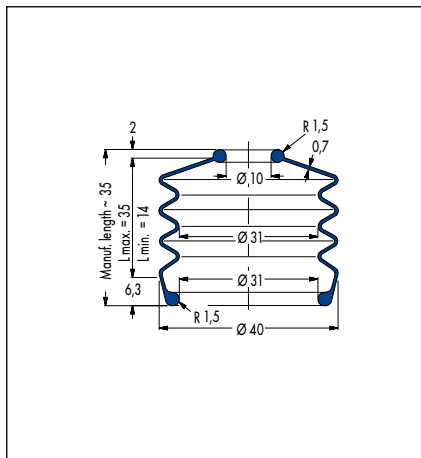

V6-00555, Article No. 438572

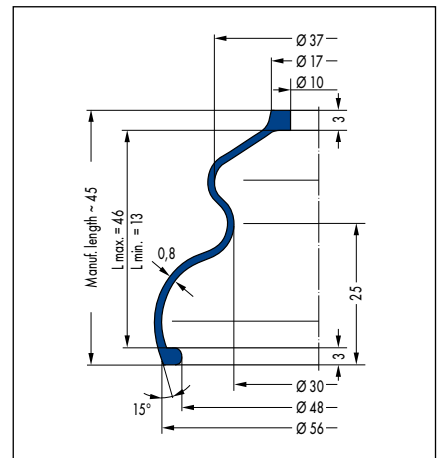

V6-00945, Article No. 413

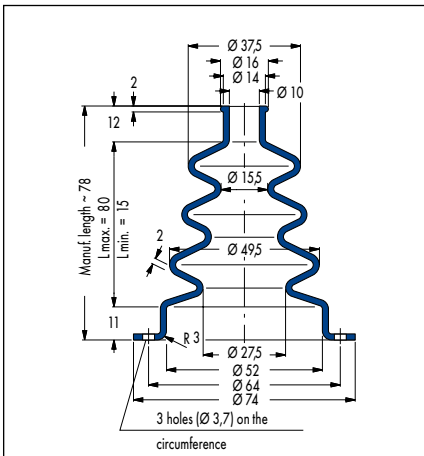

V6-01348, Article No. 429741 (50 CR 879)/  
430248 (42 CR 764)

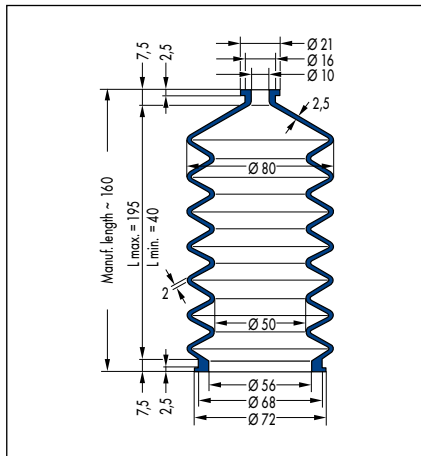

V6-00741, Article No. 456488

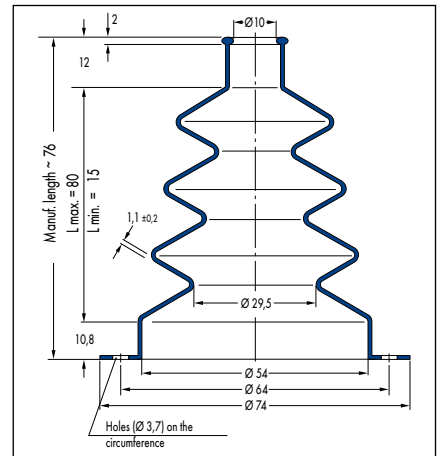

V6-20024, Article No. 49332671

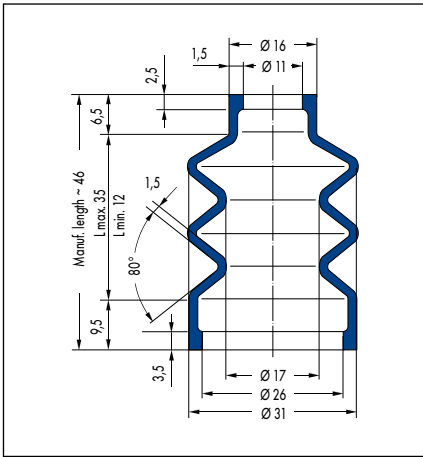

V6-00833, Article No. 400864

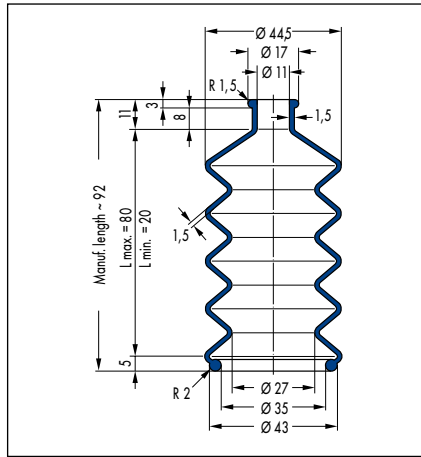

V6-00829, Article No. 507862

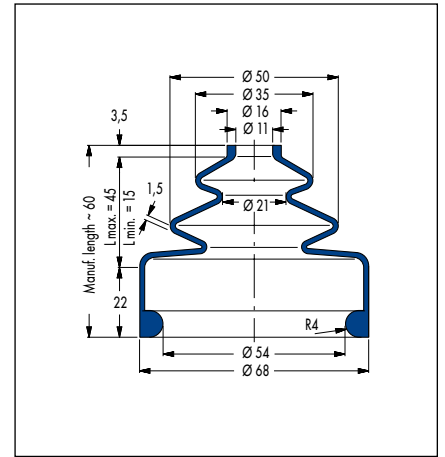

V6-00111, Article No. 434031

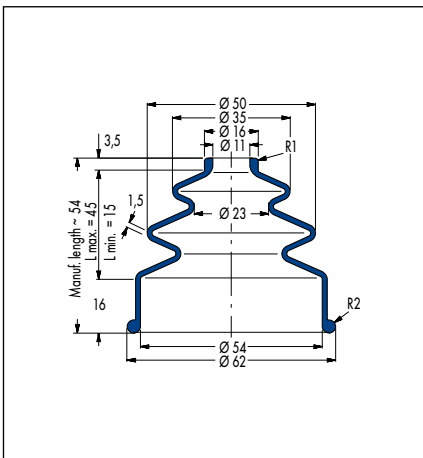

V6-00320, Article No. 440257

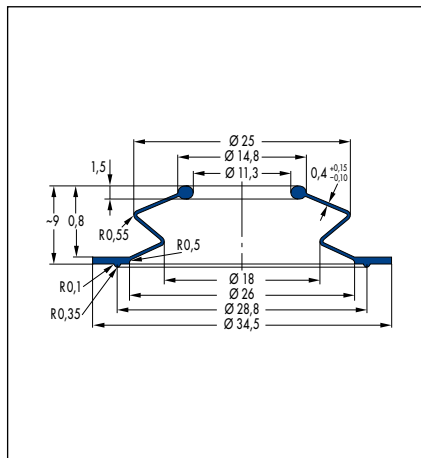

V6-20123, Article No. 49365014

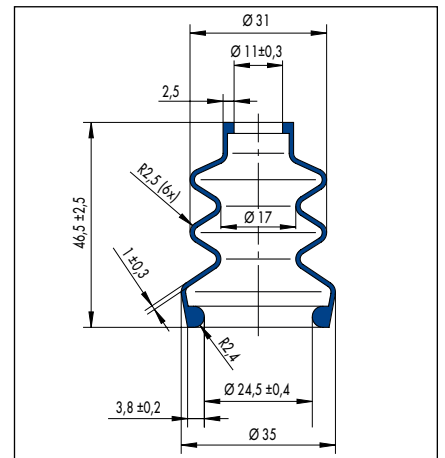

V6-01303, Article No. 49469788

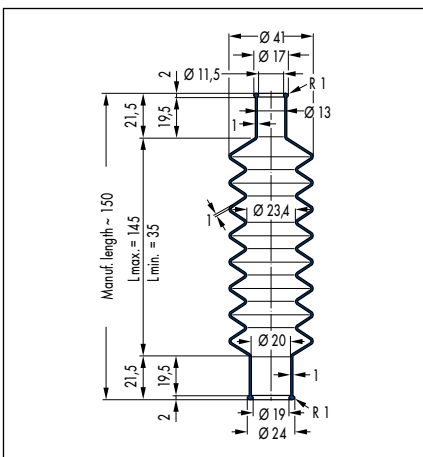

V6-00836, Article No. 400869

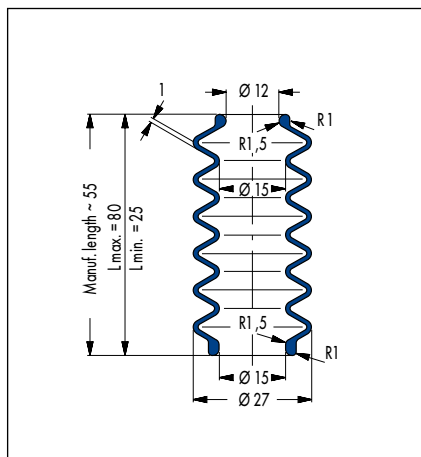

V6-00158, Article No. 430845

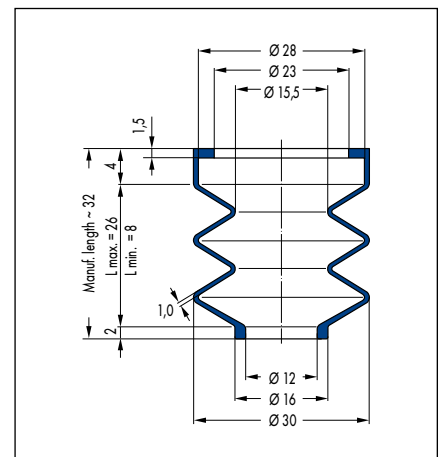

V6-01585, Article No. 49346744

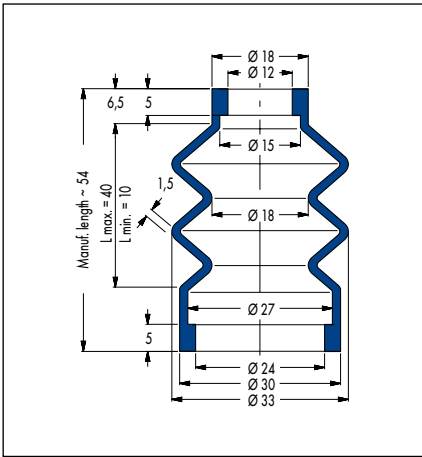

V6-00288, Article No. 452930

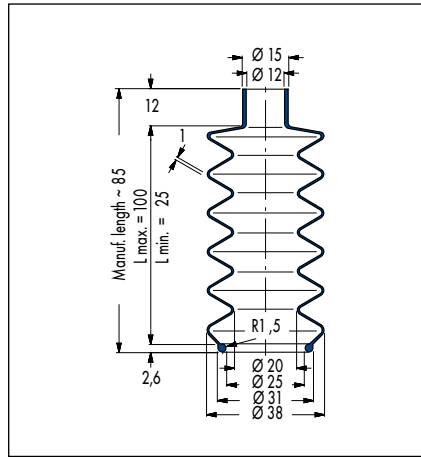

V6-00650, Article No. 428275

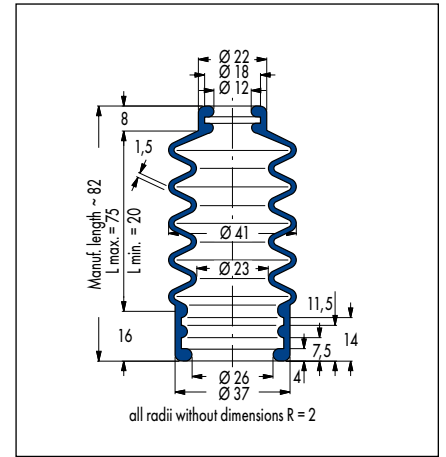

V6-00022, Article No. 49345169

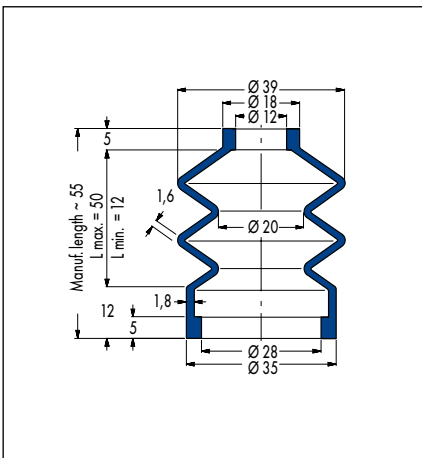

V6-00289, Article No. 439474

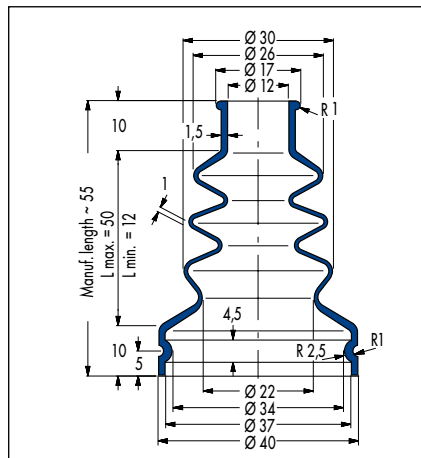

V6-00716, Article No. 427272

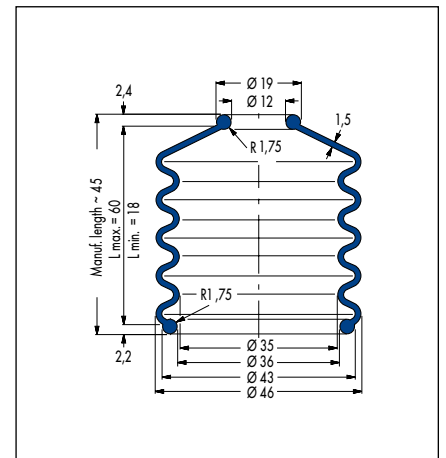

V6-00880, Article No. 438558

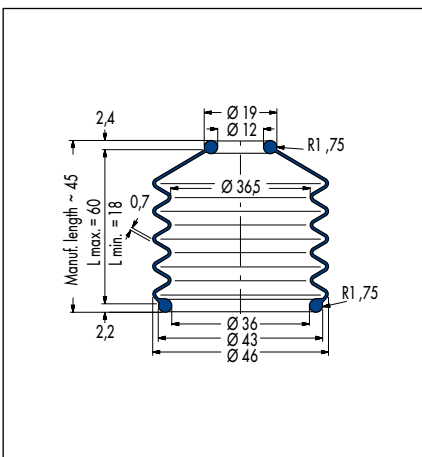

V6-00580, Article No. 66382 (50 CR 879)/  
81222 (42 CR 764)

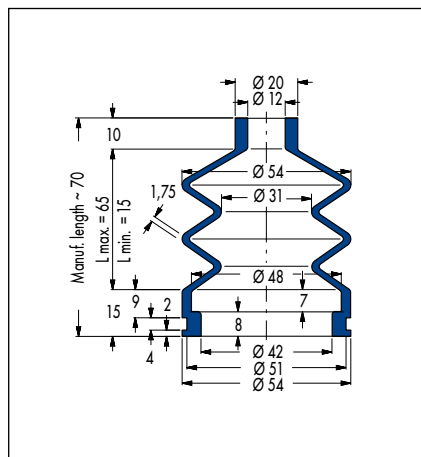

V6-00423, Article No. 435215

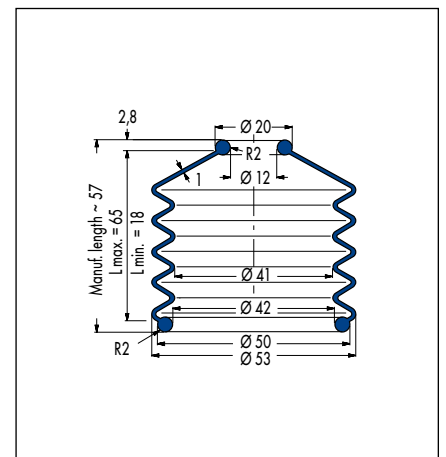

V6-00581, Article No. 438541 (CR)/  
438542 (NBR)

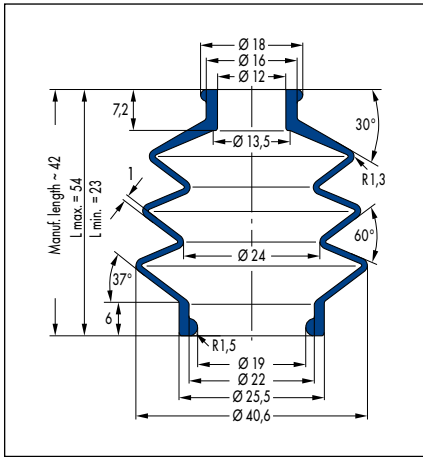

V6-20121, Article No. 49365013

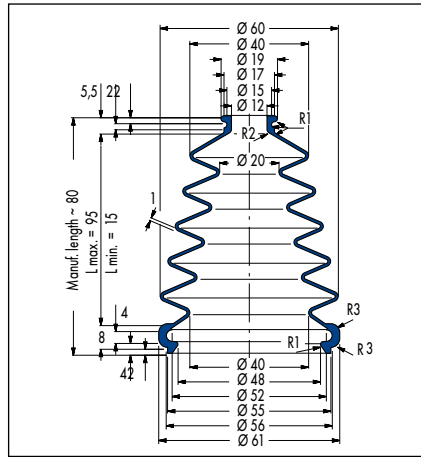

V6-00625, Article No. 438216

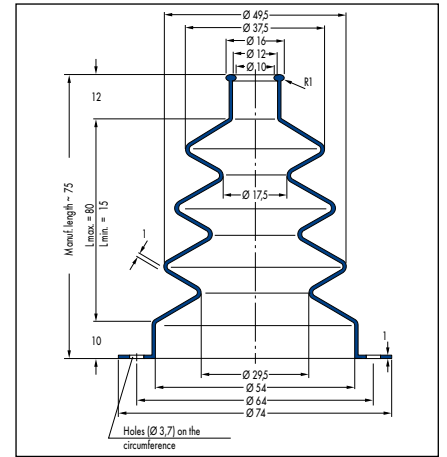

V6-00631, Article No. 426386 (CR)/  
508013 (NBR)

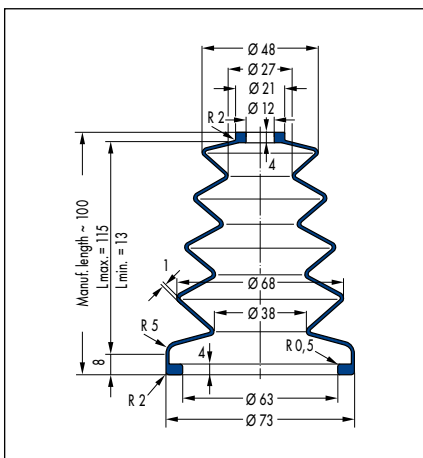

V6-01014, Article No. 454262

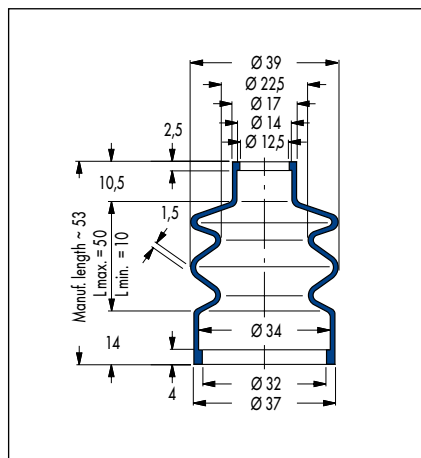

V6-00816, Article No. 434459

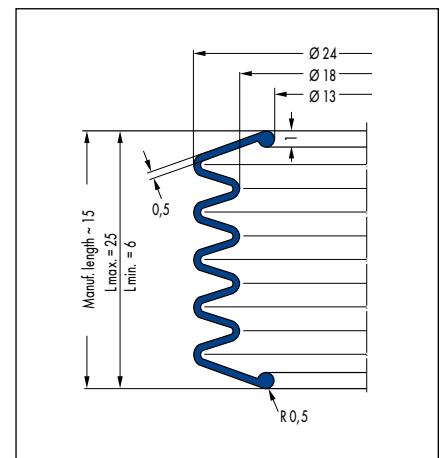

V6-00989, Article No. 117054

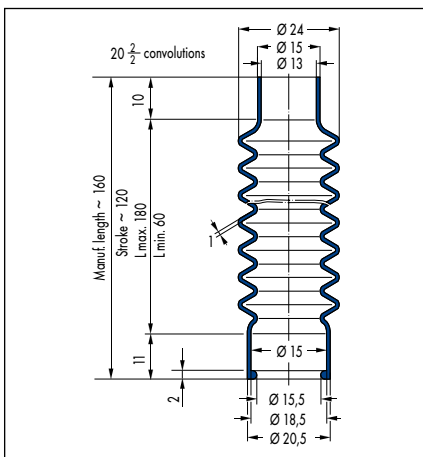

V6-00930, Article No. 400893

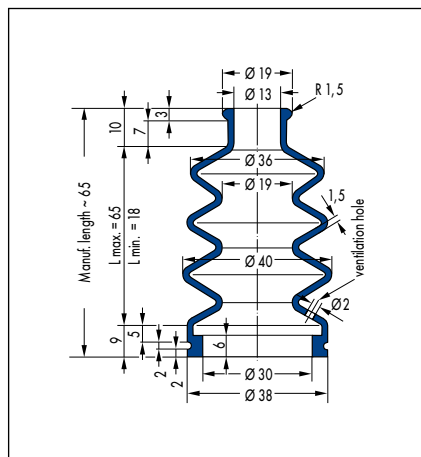

V6-00505, Article No. 453725

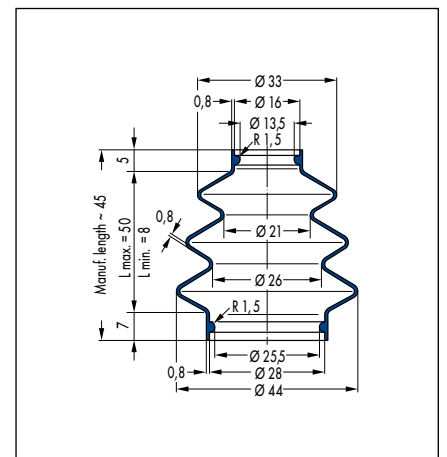

V6-00616, Article No. 400781

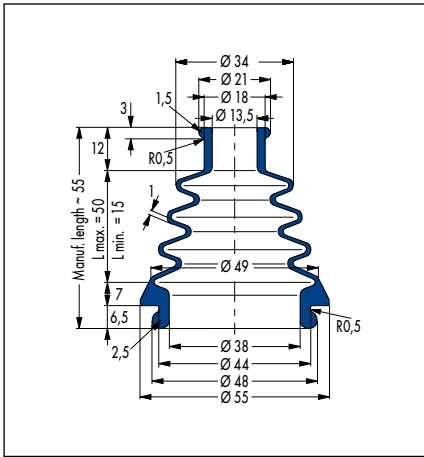

V6-00360, Article No. 49319193

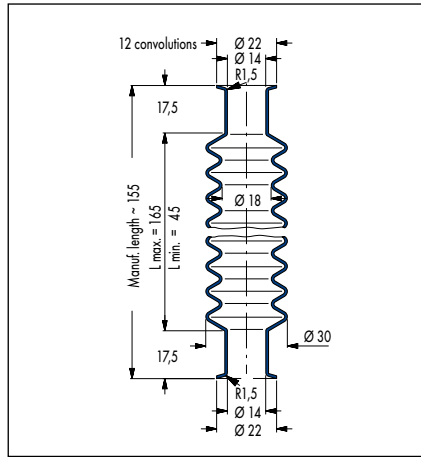

V6-00237, Article No. 427261

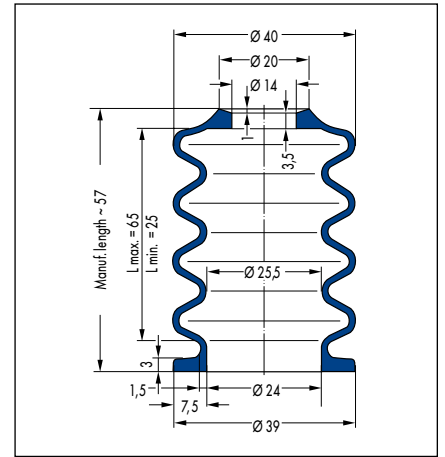

V6-00439, Article No. 29637

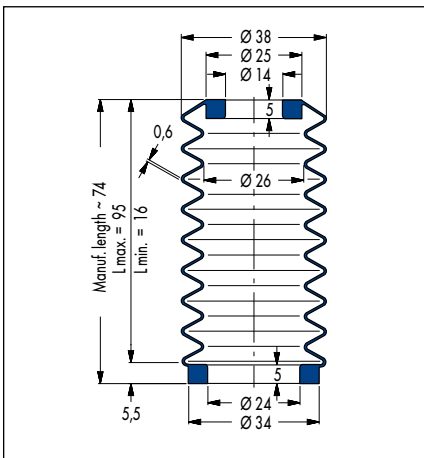

V6-00905, Article No. 428836, 437671 (42 CR 764)

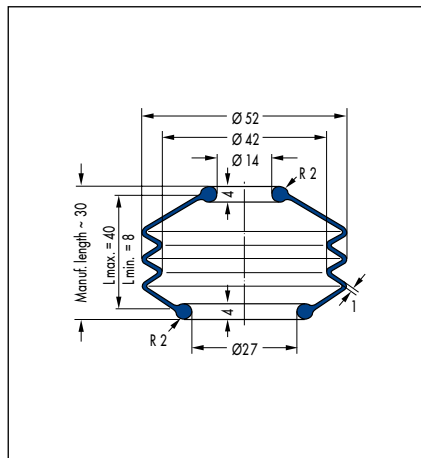

V6-00644, Article No. 49346745

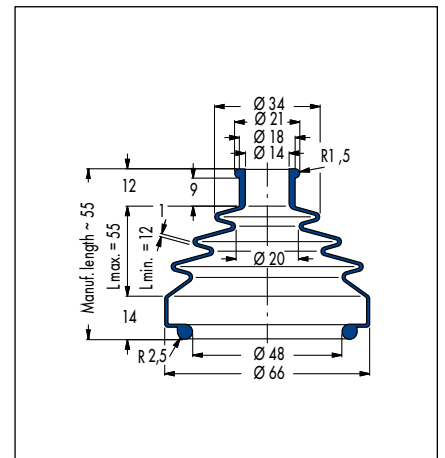

V6-00585, Article No. 436695 (50 CR 879)/ 436697 (42 CR 764)

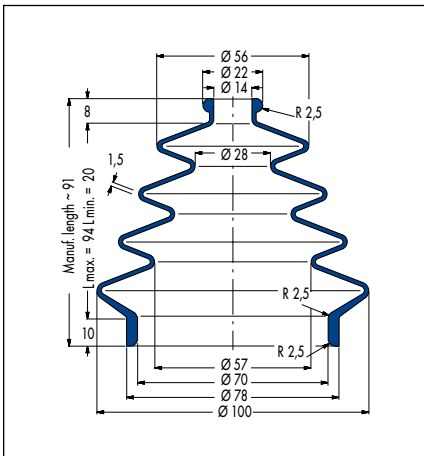

V6-01358, Article No. 451650

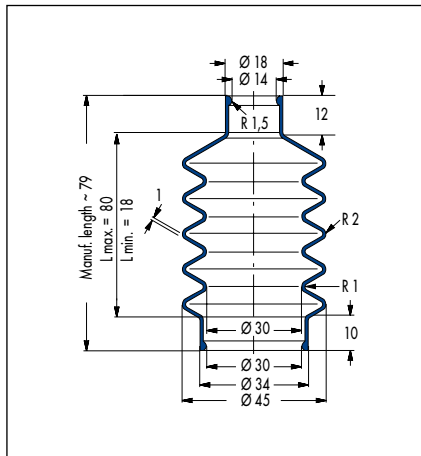

V6-00988, Article No. 385391

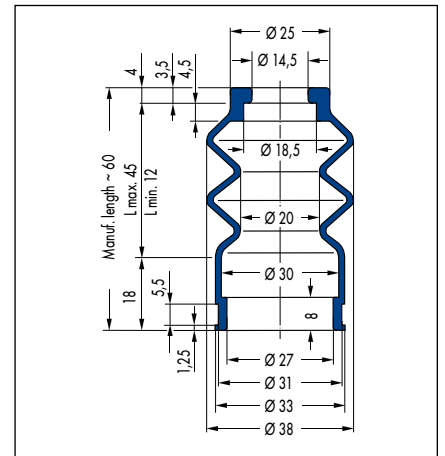

V6-00189, Article No. 440390

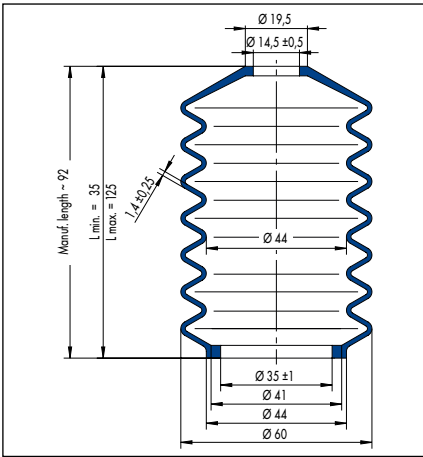

V6-01332, Article No. 49469786

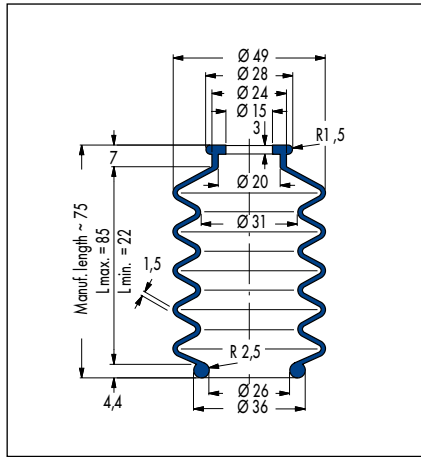

V6-00488, Article No. 426793

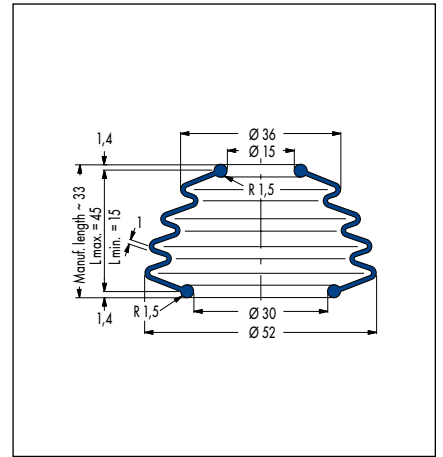

V6-00277, Article No. 435217

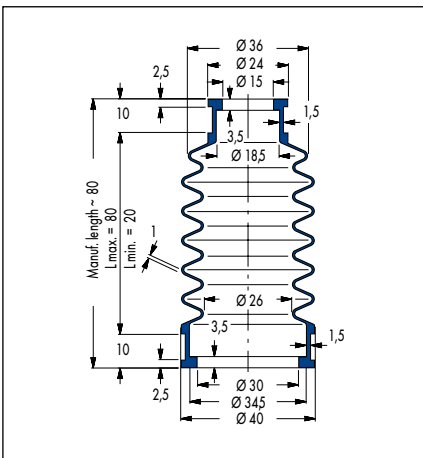

V6-00156, Article No. 436158

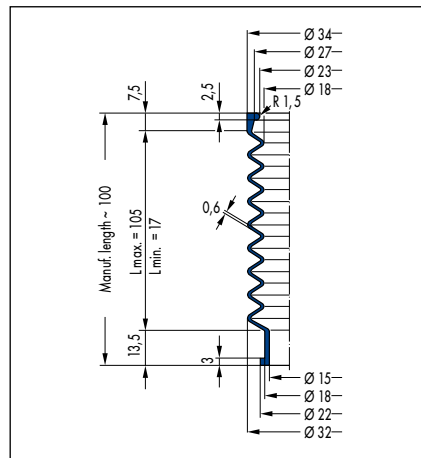

V6-01450, Article No. 452567

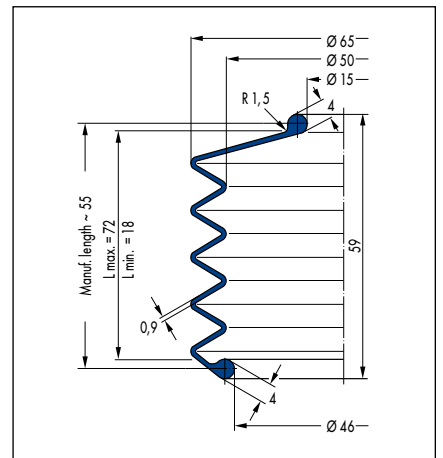

V6-01538, Article No. 434075

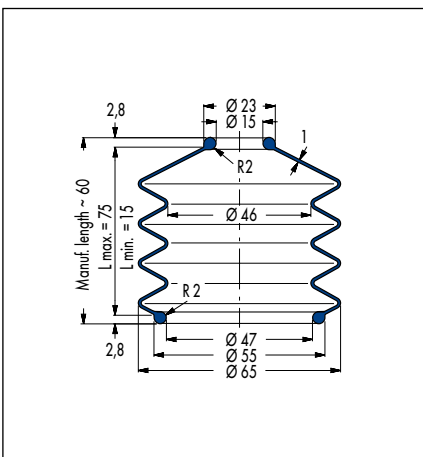

V6-00582, Article No. 49312586 (CR)

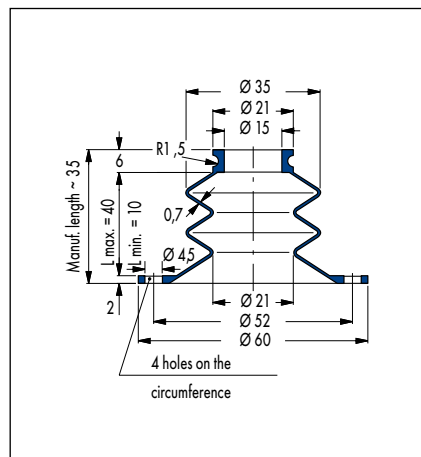

V6-00366, Article No. 427266

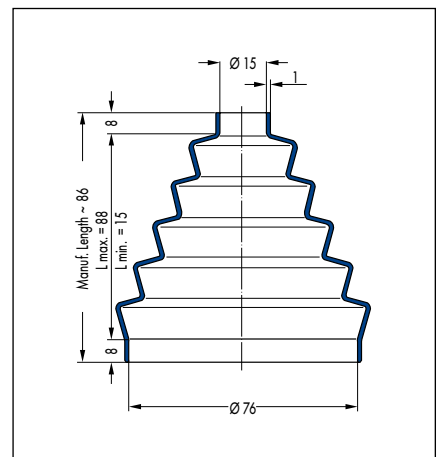

V6-00116, Article No. 439182 (42 CR 764)/  
439181 (50 CR 879)

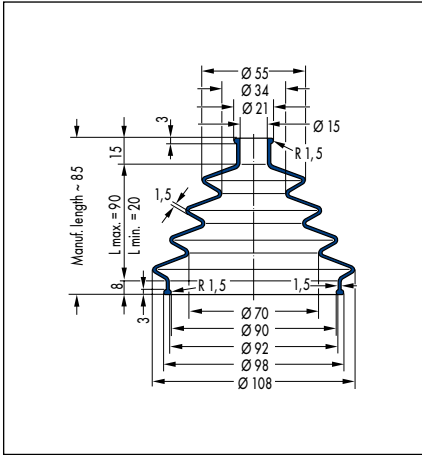

V6-00787, Article No. 29962

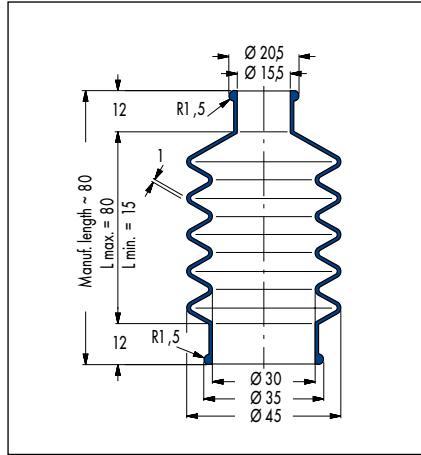

V6-01019, Article No. 438569

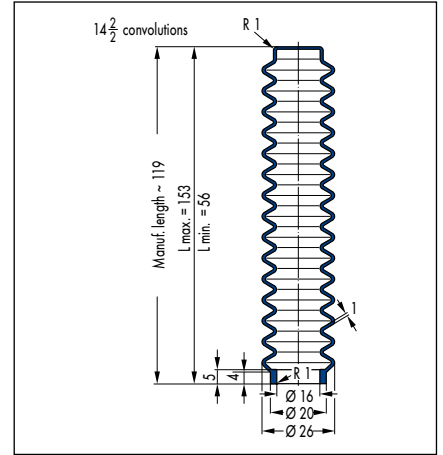

V6-01353, Article No. 82687

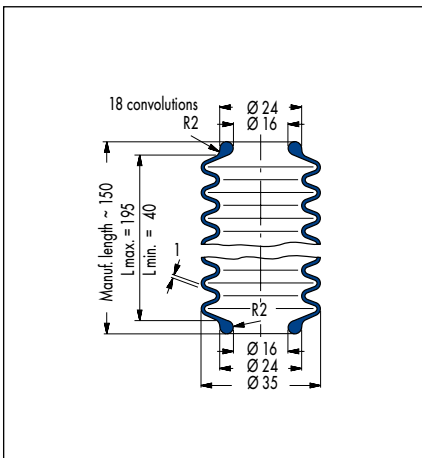

V6-00293, Article No. 434026

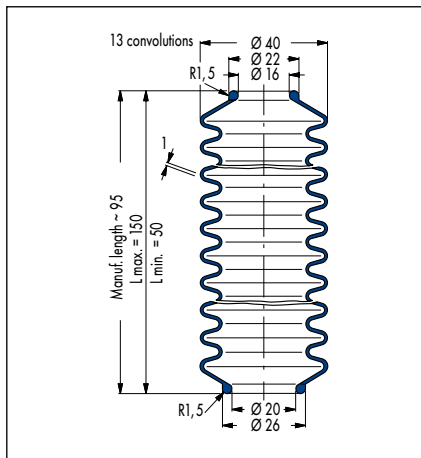

V6-00013, Article No. 438211

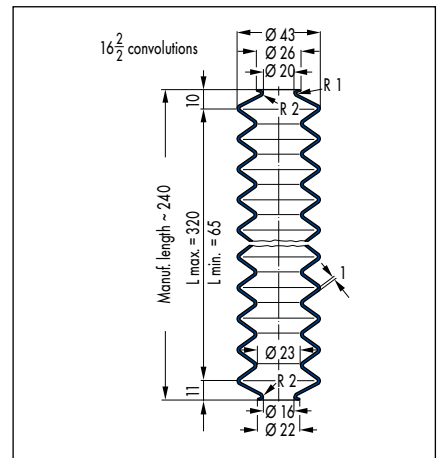

V6-00586, Article No. 431276

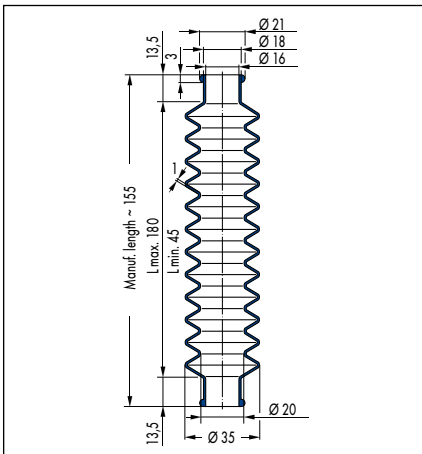

V6-00639, Article No. 400785

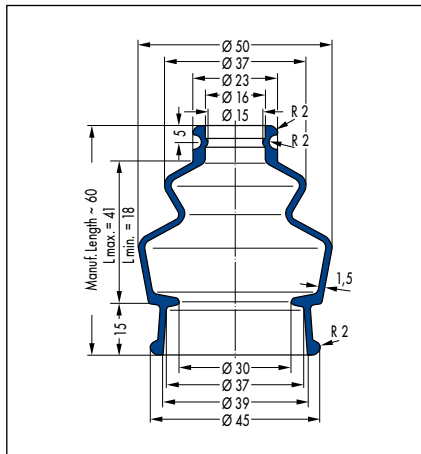

V6-00282, Article No. 440305

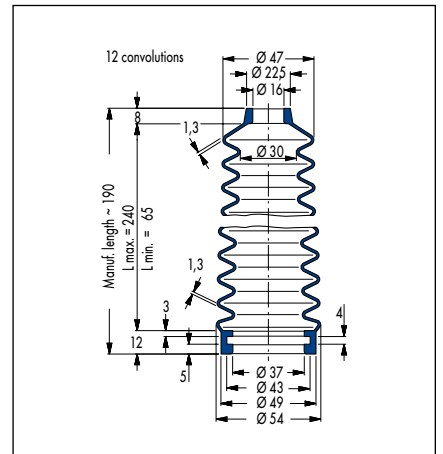

V6-00404, Article No. 428849 (CR)/  
428851 (NBR)





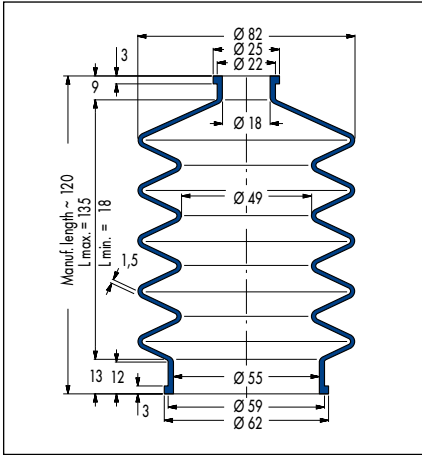

V6-00075, Article No. 439195

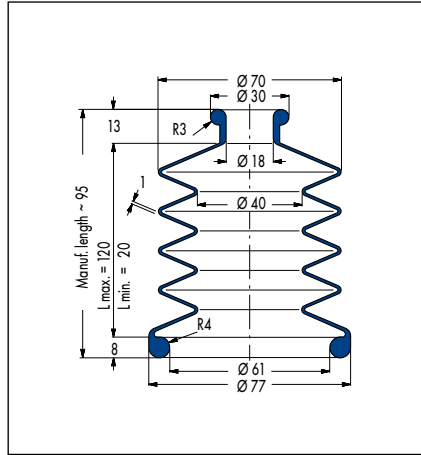

V6-00313, Article No. 440315

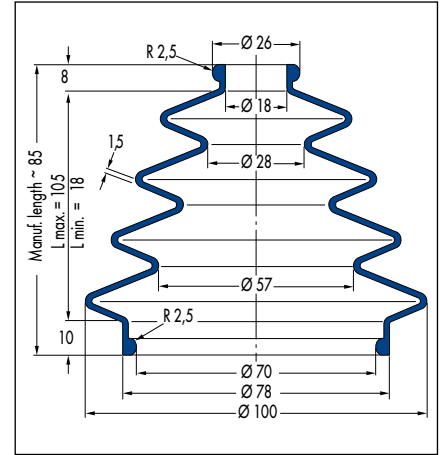

V6-00791, Article No. 426798

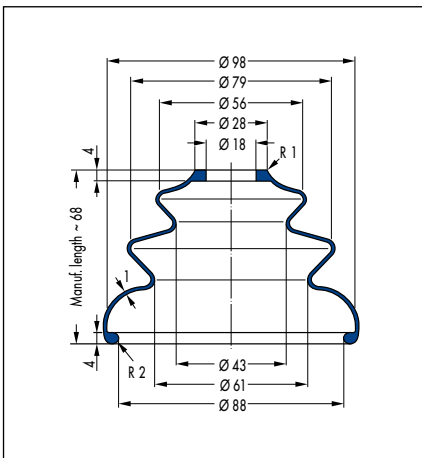

V6-00942, Article No. 450411

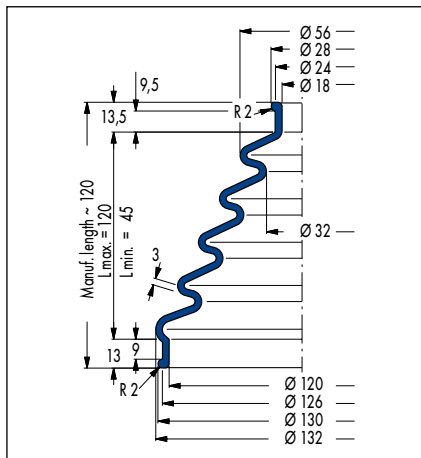

V6-00575, Article No. 29752

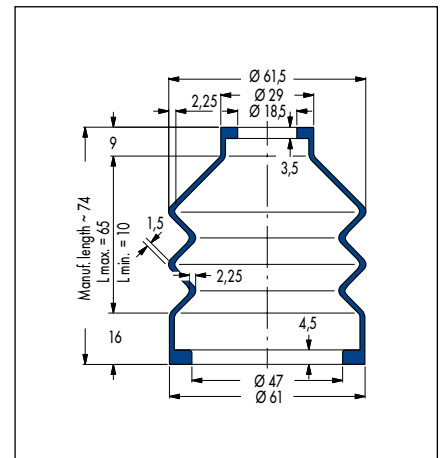

V6-00203, Article No. 49312517

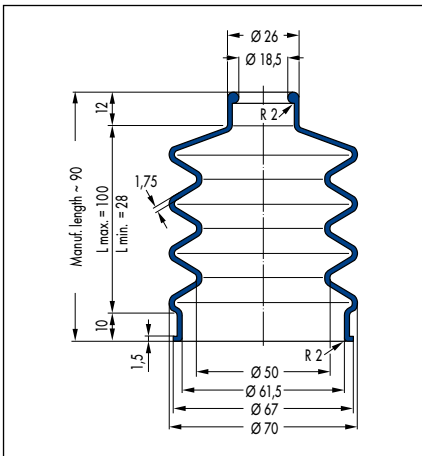

V6-00843, Article No. 432191

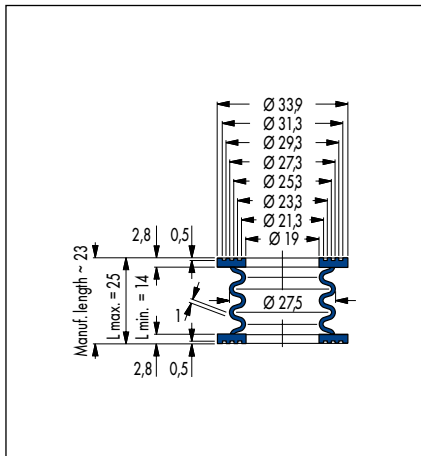

V6-00383, Article No. 430846

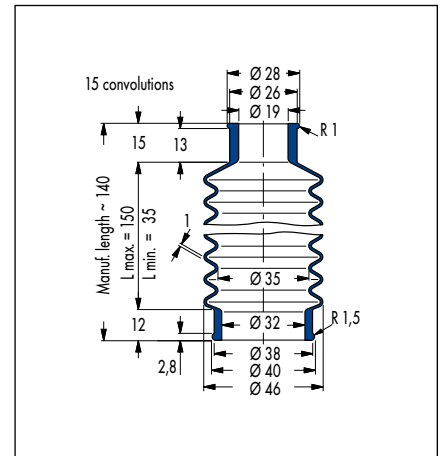

V6-00679, Article No. 426799

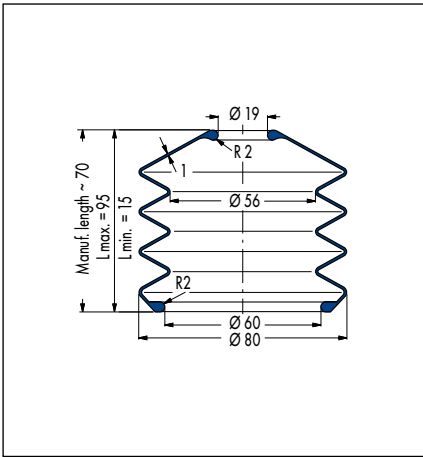

V6-00565, Article No. 434030

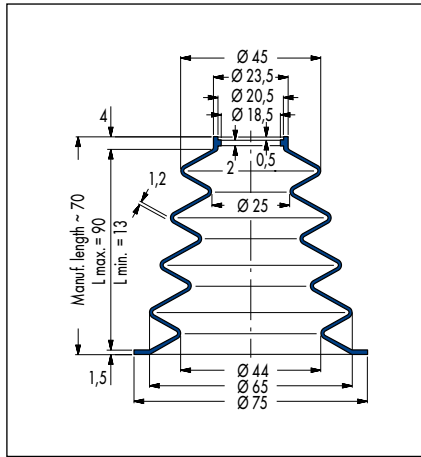

V6-00714, Article No. 427269 (42 CR 764)/  
427271 (45 NBR 670)

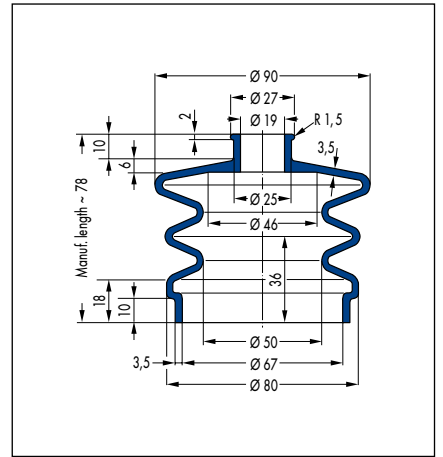

V6-20199, Article No. 501112

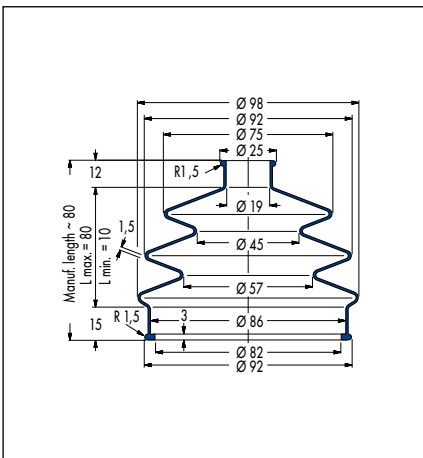

V6-00955, Article No. 429670

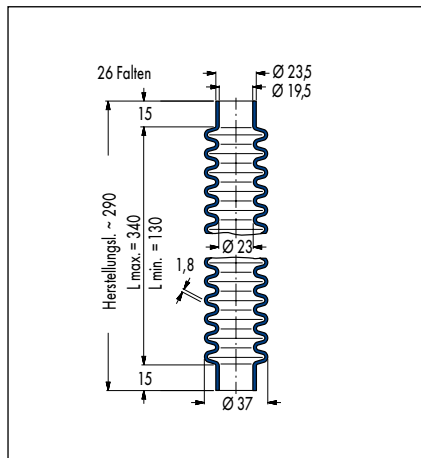

V6-00915, Article No. 440260

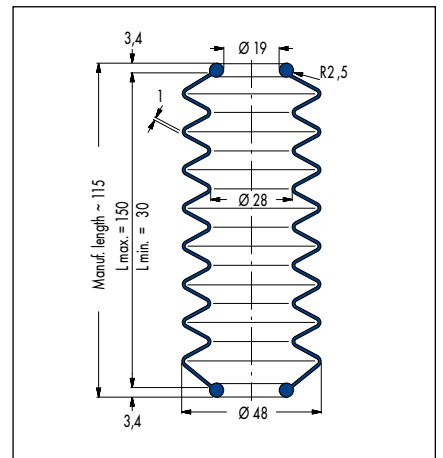

V6-00726, Article No. 426387 (CR)/  
429078 (NBR)

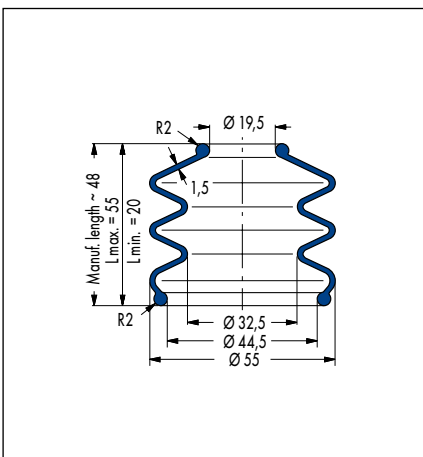

V6-00130, Article No. 437298

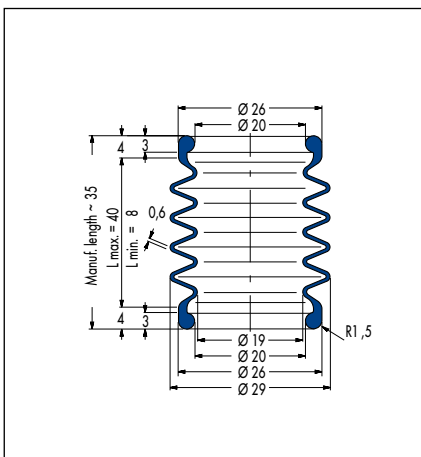

V6-00722, Article No. 336382

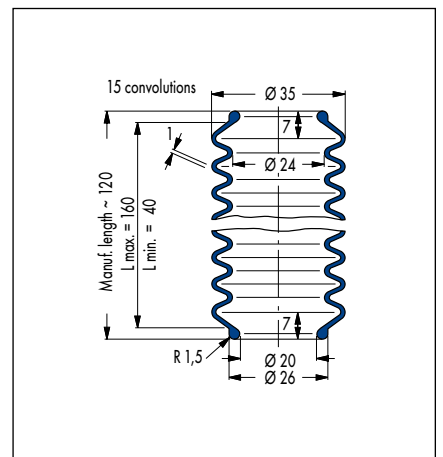

V6-00236, Article No. 449345231 (CR)/  
49344842 (NBR)

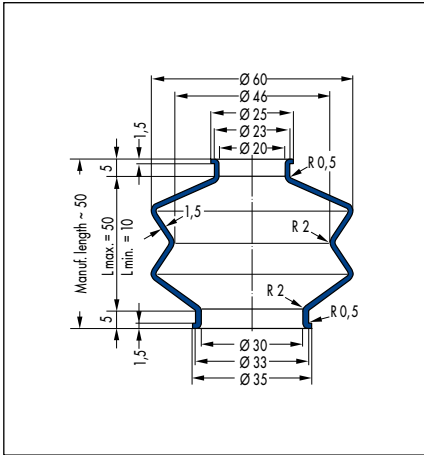

V6-00274, Article No. 439432

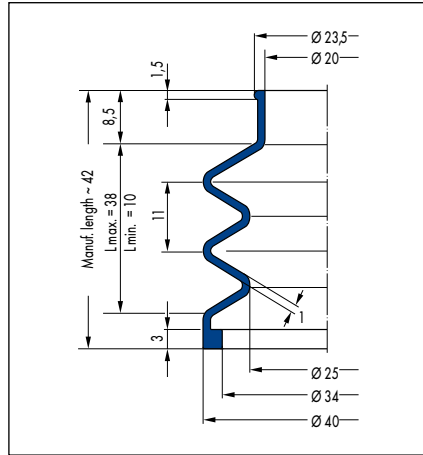

V6-01390, Article No. 400988 (CR)/  
49070147 (NBR)

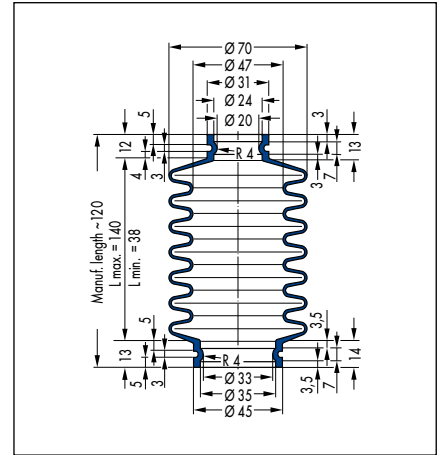

V6-00218, Article No. 430858

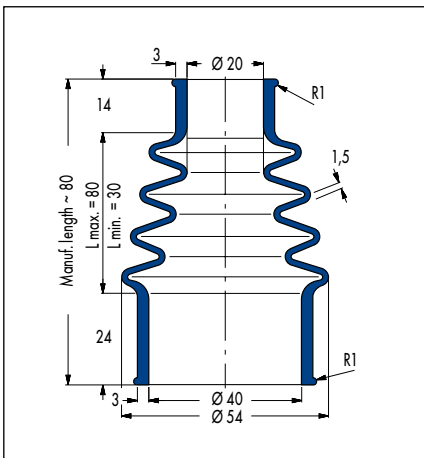

V6-01544, Article No. 301805

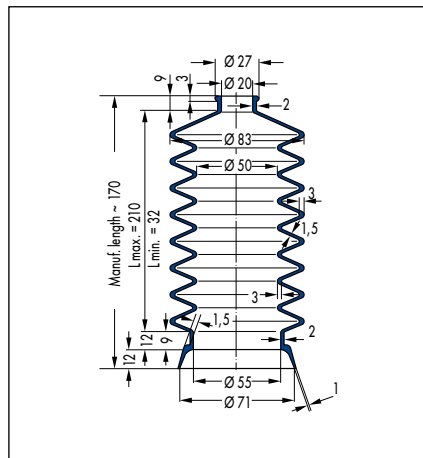

V6-00434, Article No. 438213

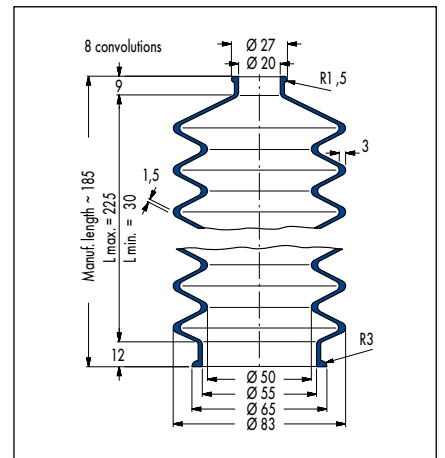

V6-00861, Article No. 429667 (42 CR 764)/  
429668 (50 CR 879)

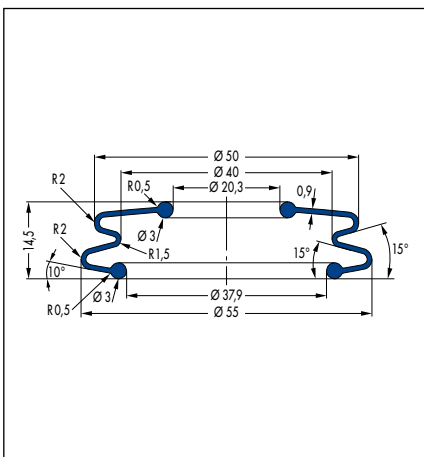

V6-20105, Article No. 49332672

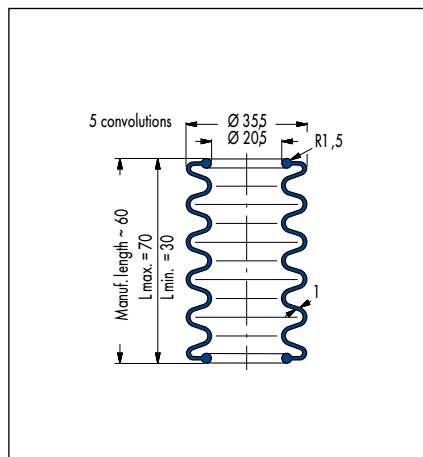

V6-00302, Article No. 440318

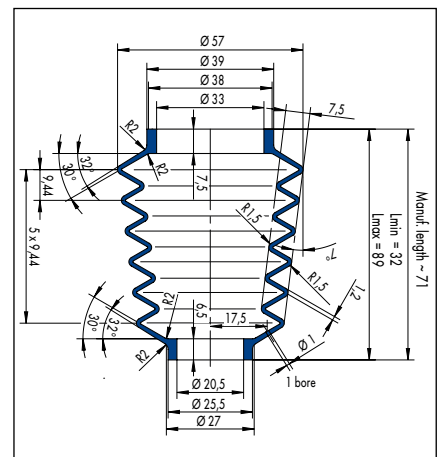

V6-20102, Article No. 49469830

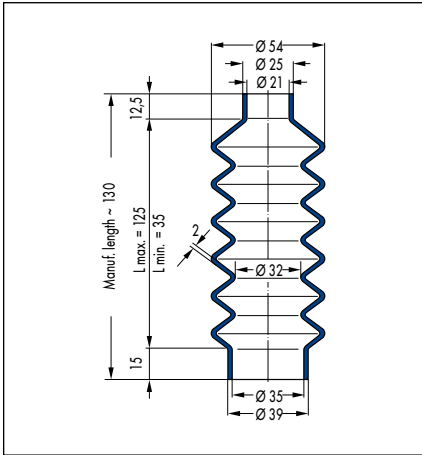

V6-00792, Article No. 430861

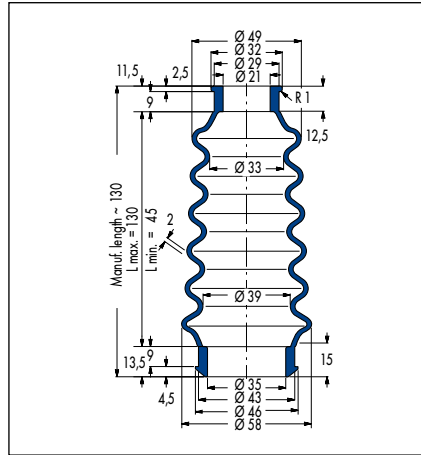

V6-00195, Article No. 436916

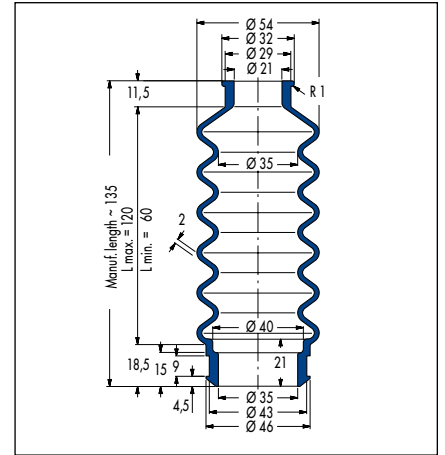

V6-00305, Article No. 426323

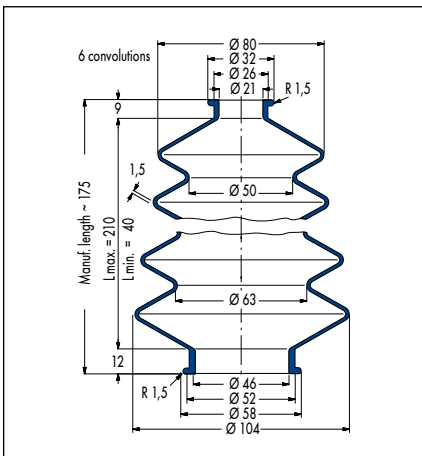

V6-00365, Article No. 431649

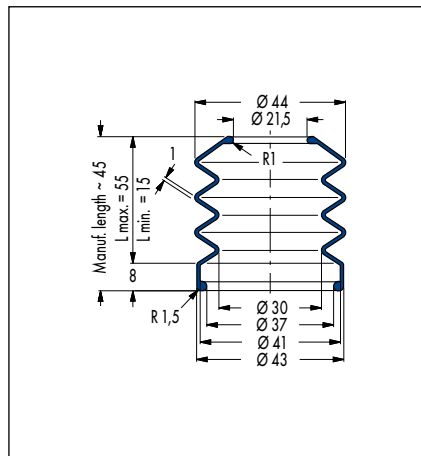

V6-00570, Article No. 436744

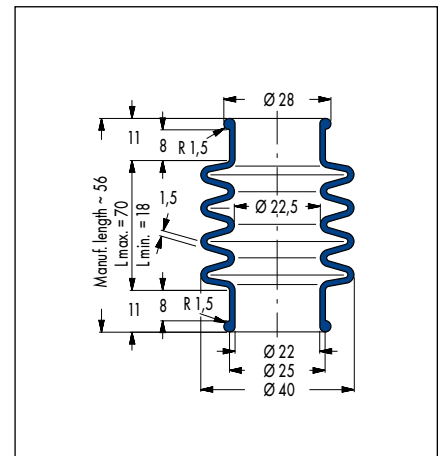

V6-00227, Article No. 439167

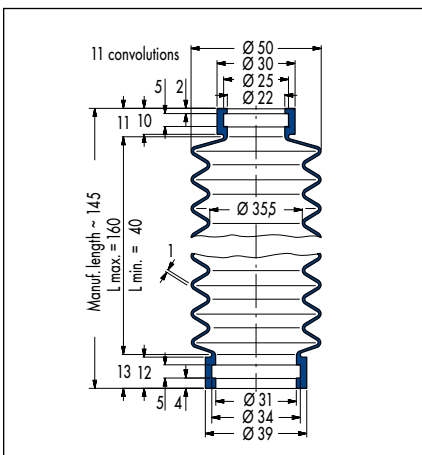

V6-00273, Article No. 426370

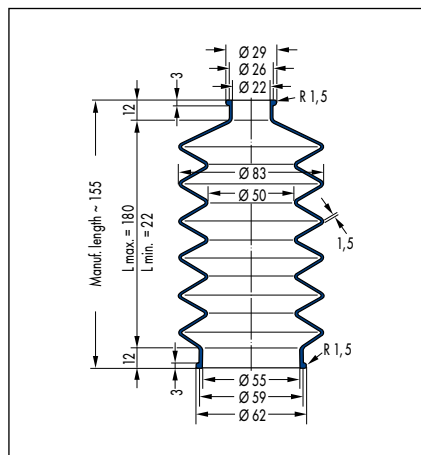

V6-00490, Article No. 457774

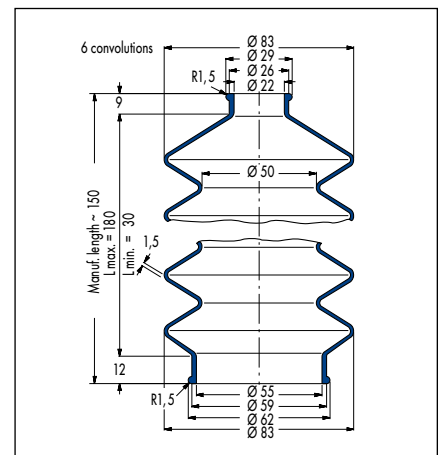

V6-00095, Article No. 438519

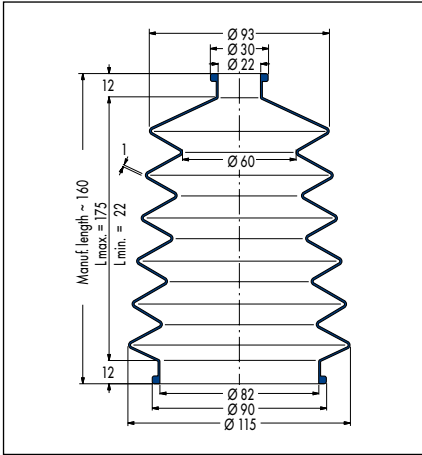

V6-00212, Article No. 439178

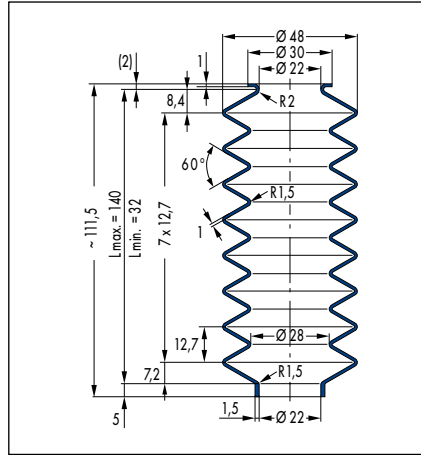

V6-01800, Article No. 49365011

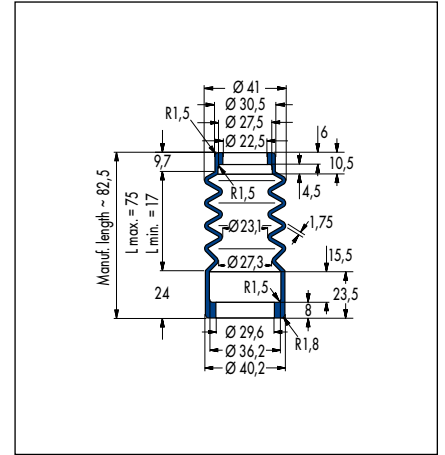

V6-00264, Article No. 49322223

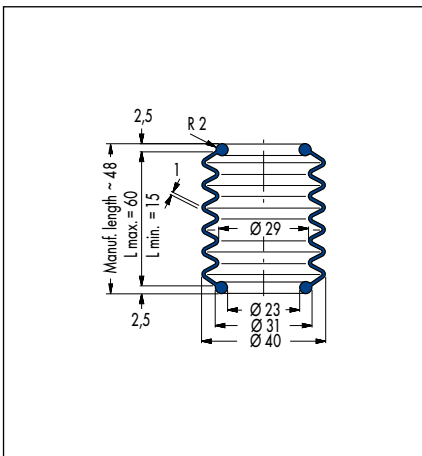

V6-00773, Article No. 435481

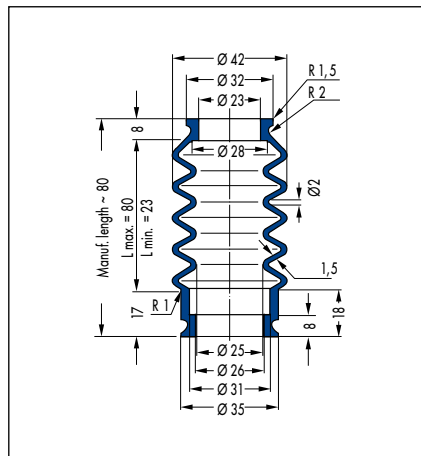

V6-00234, Article No. 440348

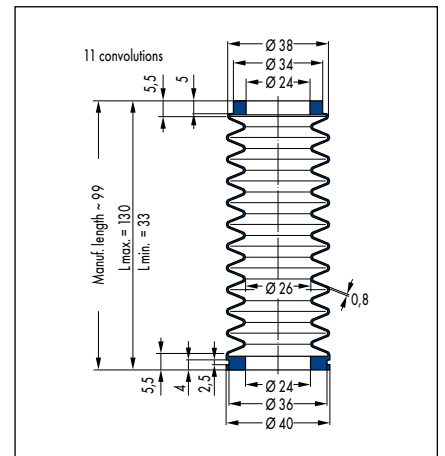

V6-20044, Article No. 384441

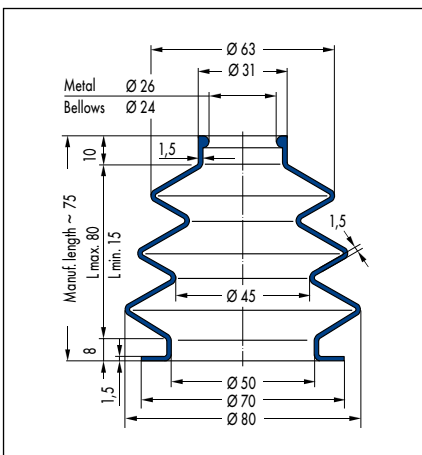

V6-00826, Article No. 456489

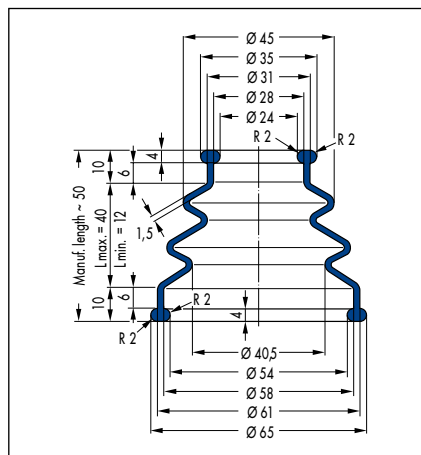

V6-00851, Article No. 457841

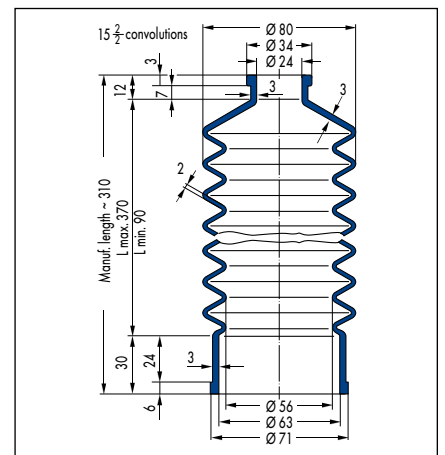

V6-00738, Article No. 60037192



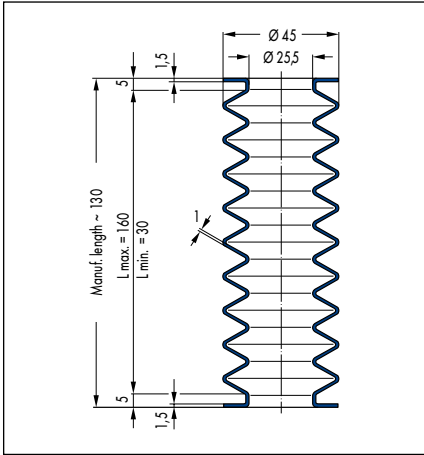

V6-00966, Article No. 350974

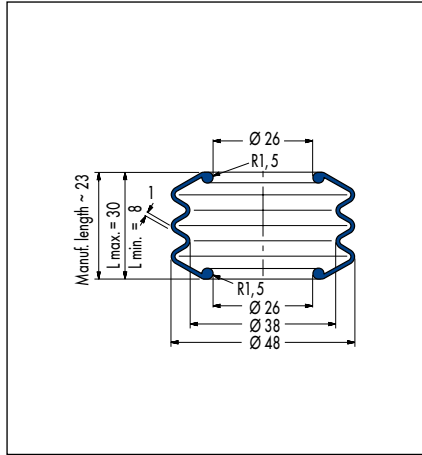

V6-00127, Article No. 432585

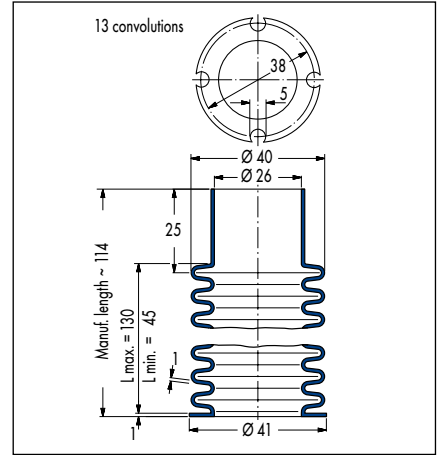

V6-00200, Article No. 438022

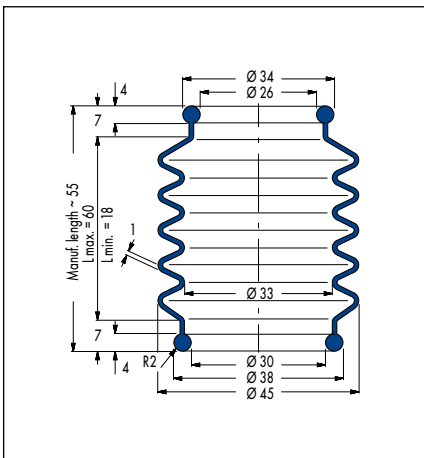

V6-00592, Article No. 426382

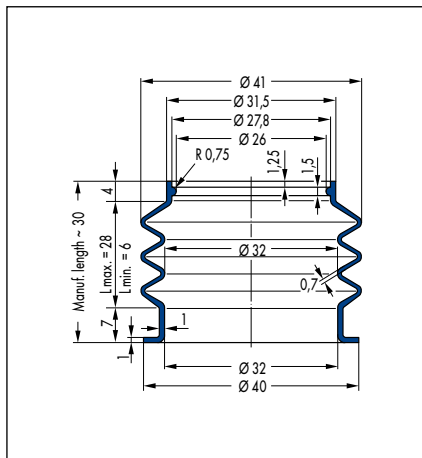

V6-00835, Article No. 452564

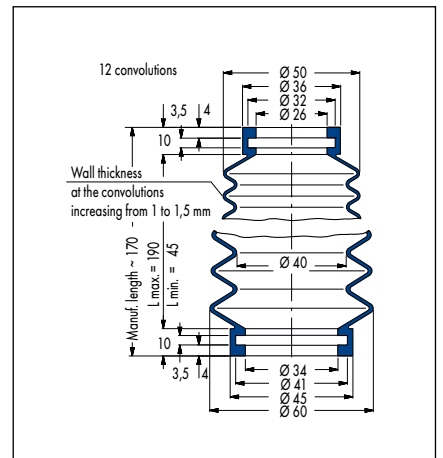

V6-00292, Article No. 436699

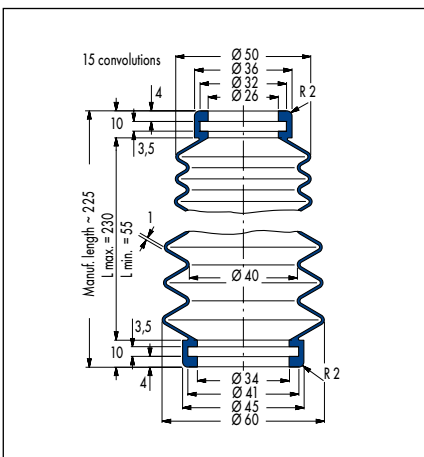

V6-00401, Article No. 440291

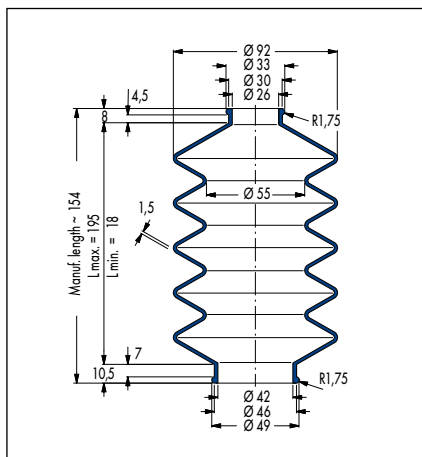

V6-00079, Article No. 431867

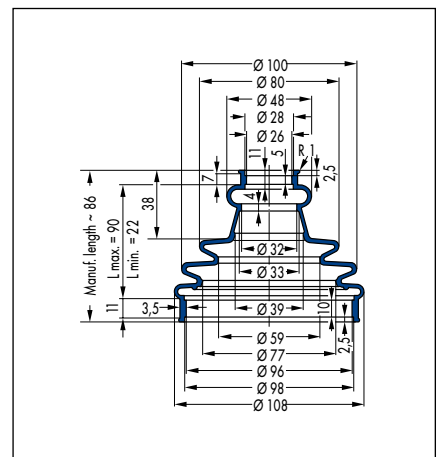

V6-01755, Article No. 451384



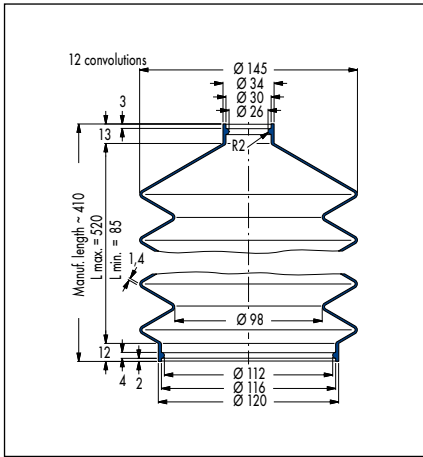

V6-01156, Article No. 454245

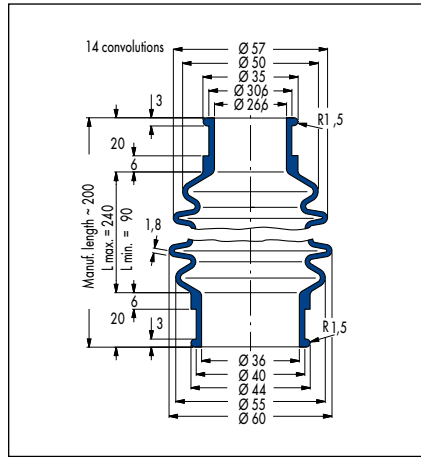

V6-00324, Article No. 440316

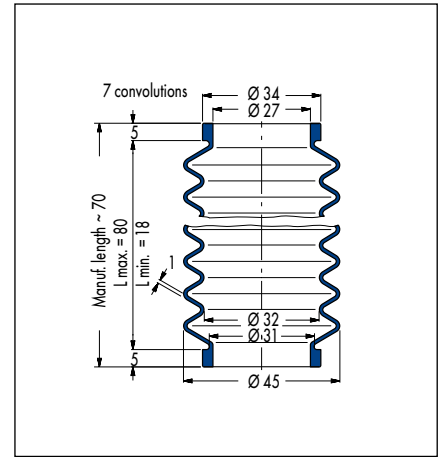

V6-00290, Article No. 432590

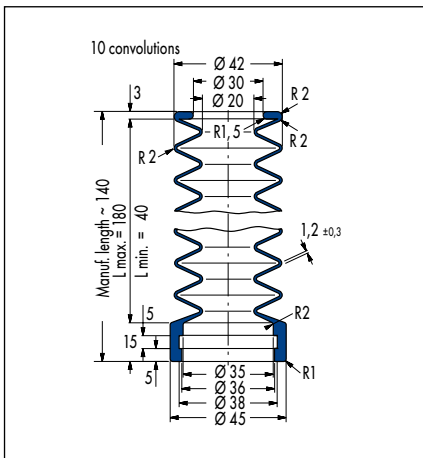

V6-00259, Article No. 439441

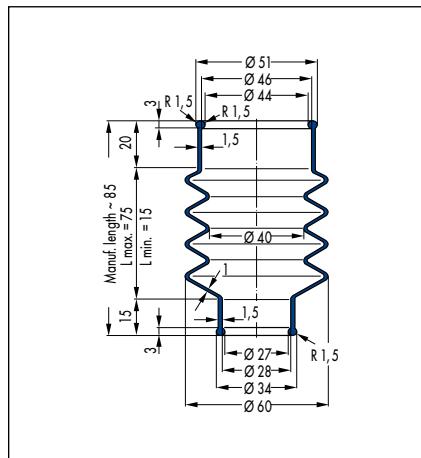

V6-00363, Article No. 432594 (CR)/  
60034466 (NBR)

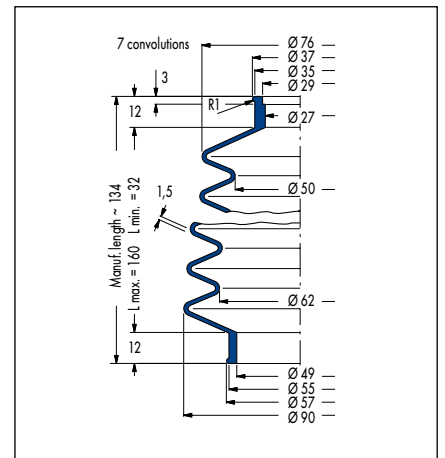

V6-00106, Article No. 430856 (NBR)/  
430857 (CR)

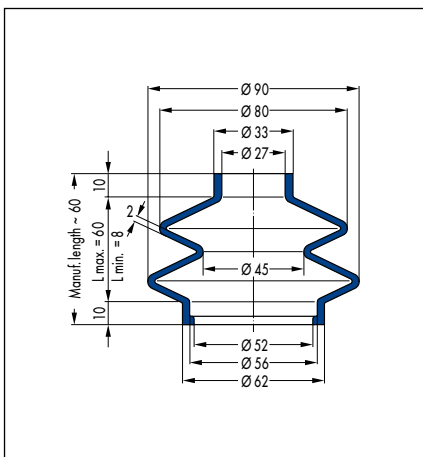

V6-01055, Article No. 457773

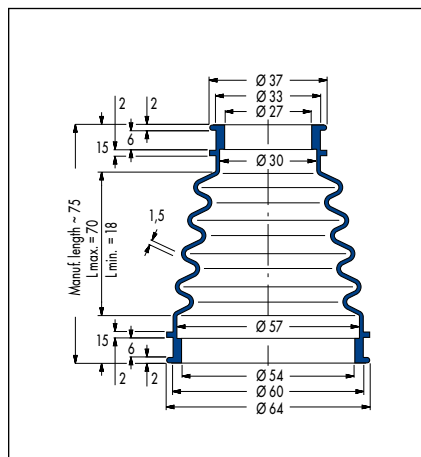

V6-00857, Article No. 49312648 (CR)/  
49059820 (NBR)

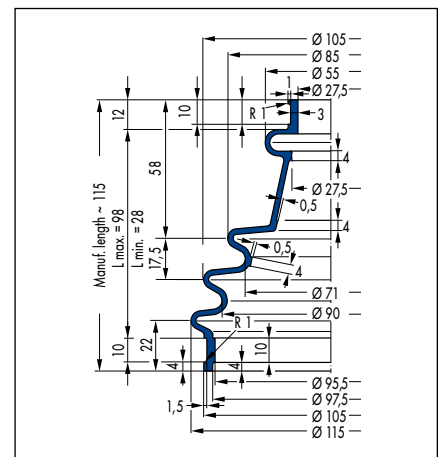

V6-01723, Article No. 438571

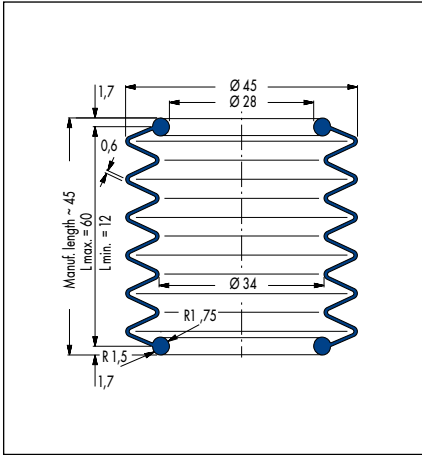

V6-00640, Article No. 427268

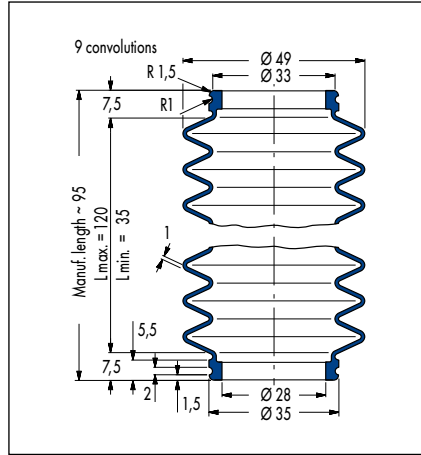

V6-00296, Article No. 426795

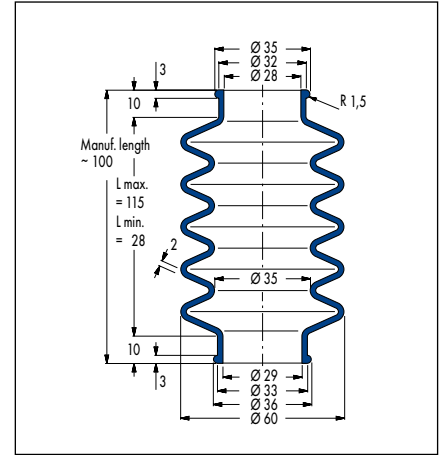

V6-00594, Article No. 429662 (CR)/  
49067648 (NBR)

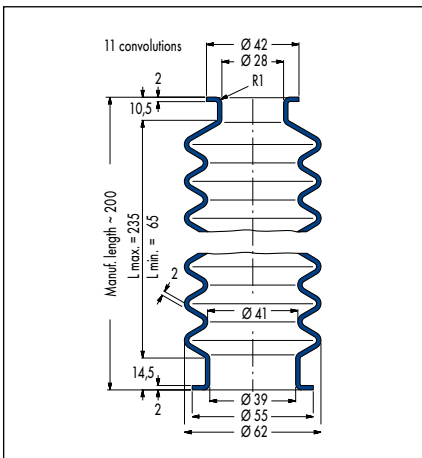

V6-00755, Article No. 451312

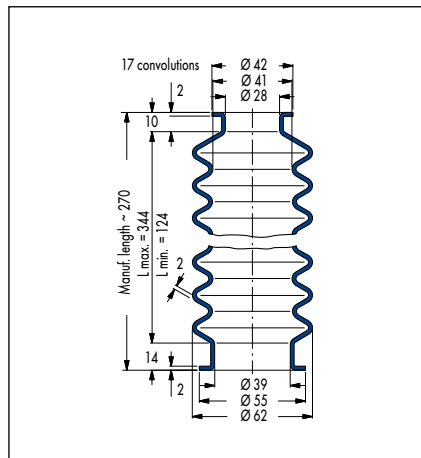

V6-00201, Article No. 49312542

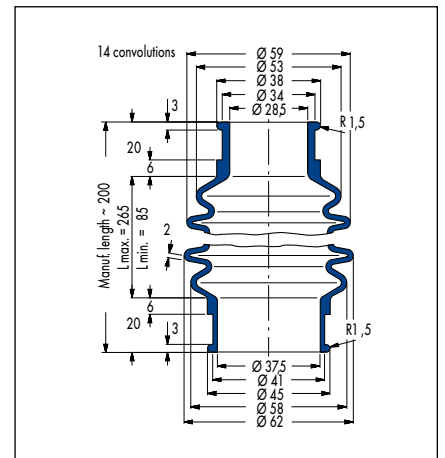

V6-00325, Article No. 426794

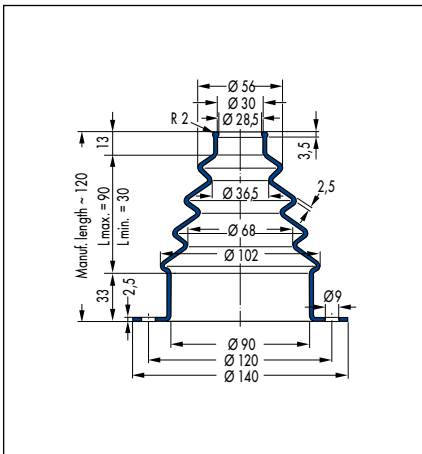

V6-00475, Article No. 400708

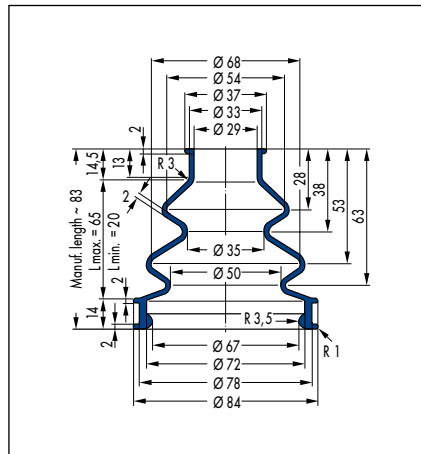

V6-01023, Article No. 454488

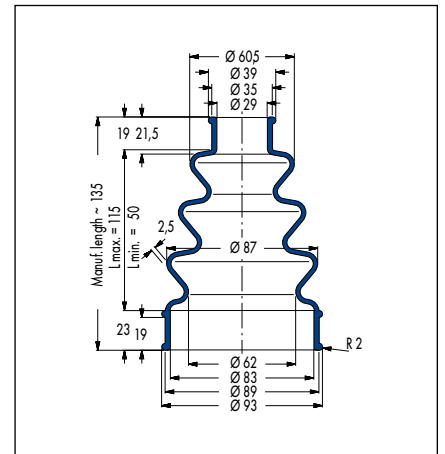

V6-00384, Article No. 440317

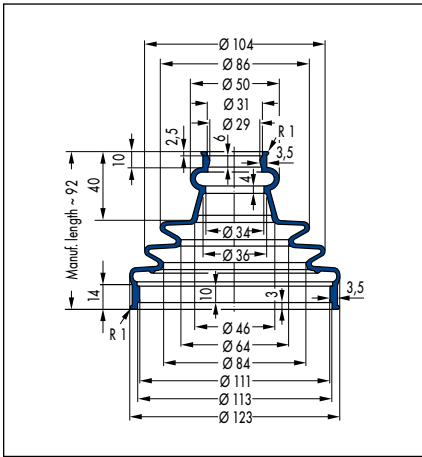

V6-01754, Article No. 451337

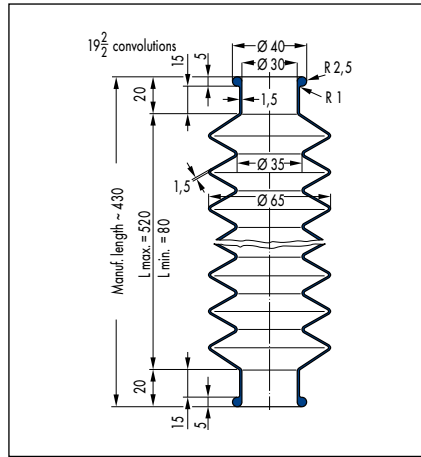

V6-00589, Article No. 15267

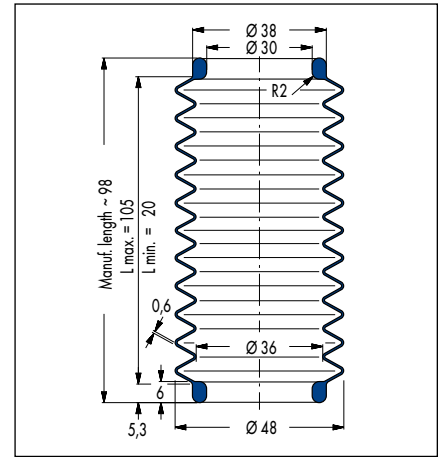

V6-00904, Article No. 375419

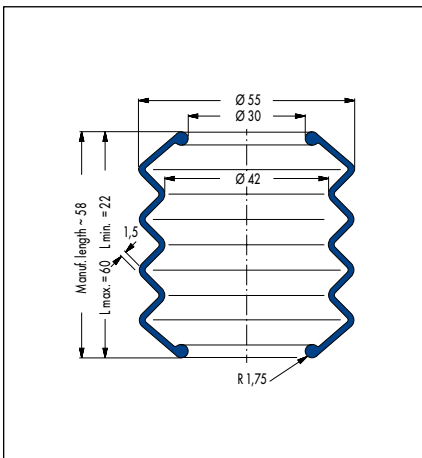

V6-00422, Article No. 428310

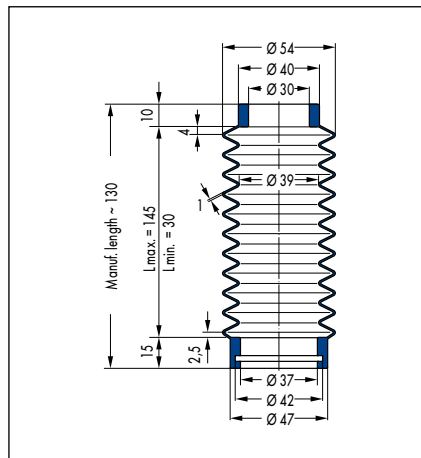

V6-00824, Article No. 368141

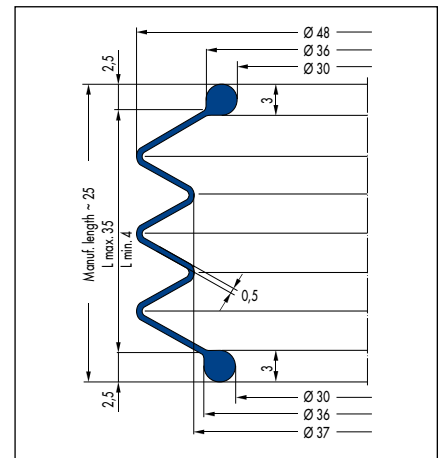

V6-00720, Article No. 400804

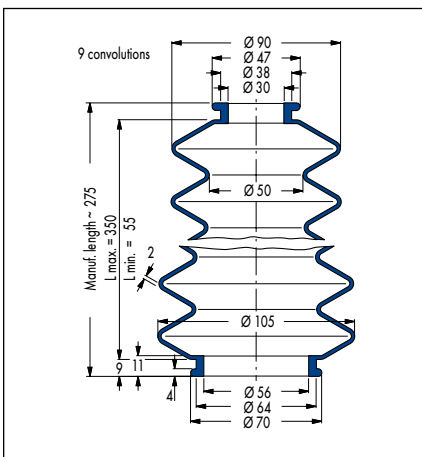

V6-00456, Article No. 49312336

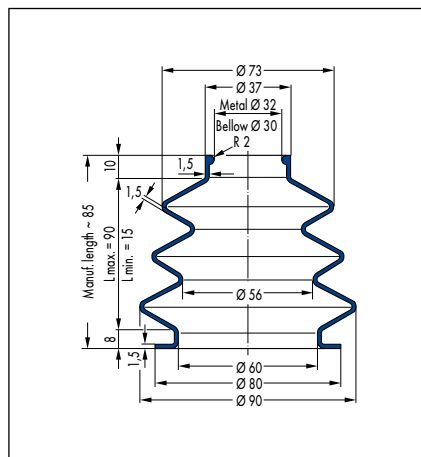

V6-00805, Article No. 365839

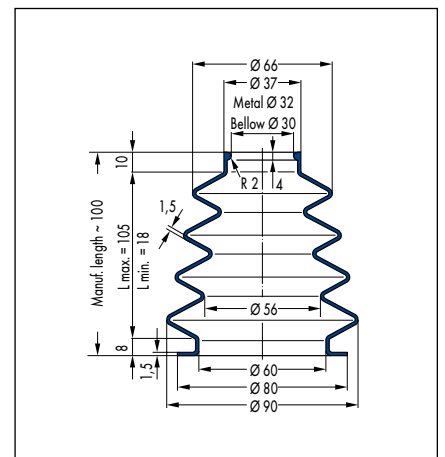

V6-00827, Article No. 355702

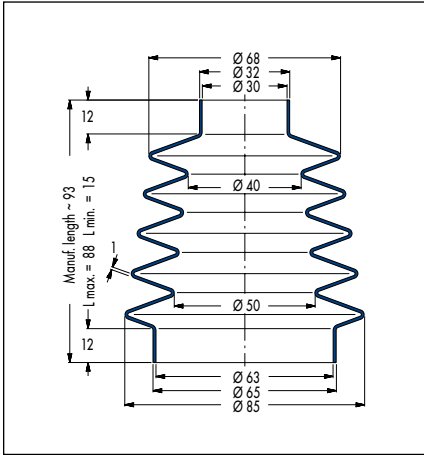

V6-01329, Article No. 60305

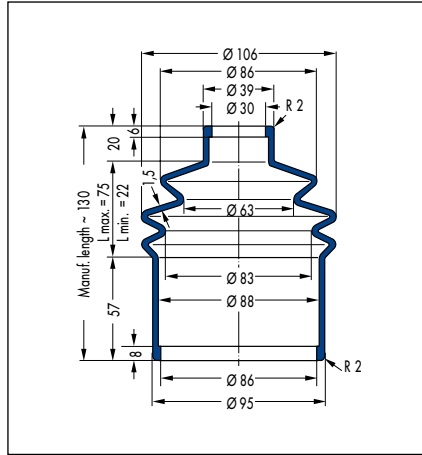

V6-00314, Article No. 451741

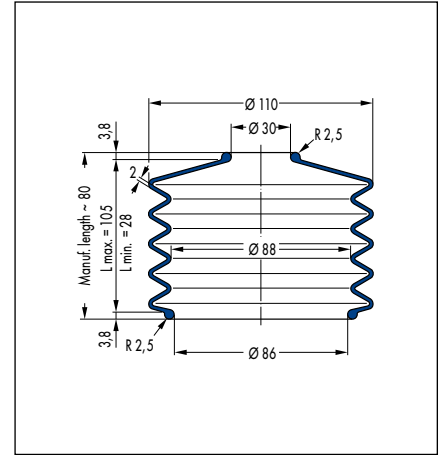

V6-00903, Article No. 438936

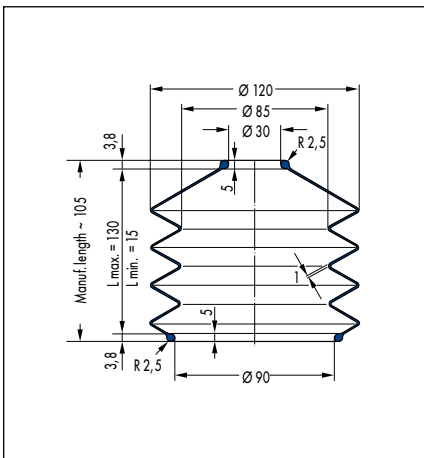

V6-00584, Article No. 375144

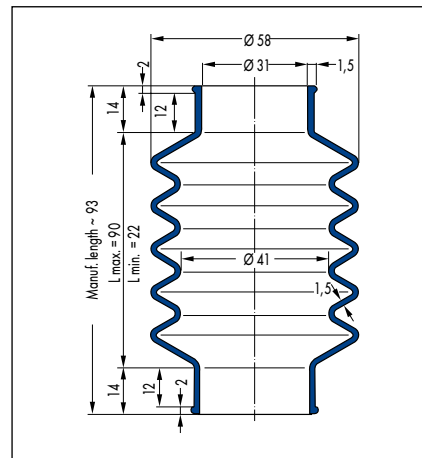

V6-00448, Article No. 122870 (50 CR 879)/  
49046170 (60 CR 176307)

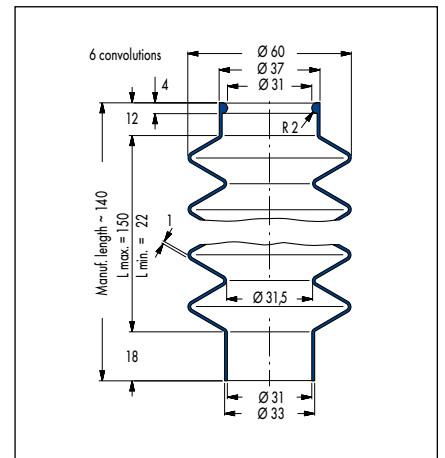

V6-00603, Article No. 438548

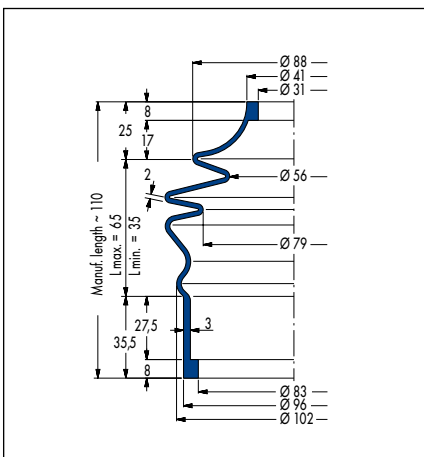

V6-00206, Article No. 428315

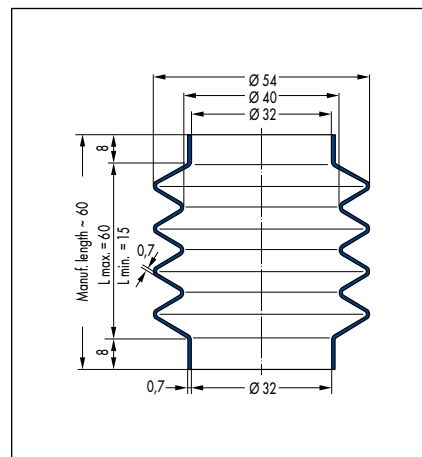

V6-01236, Article No. 436913

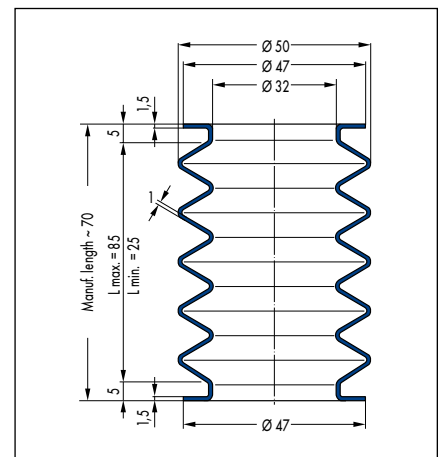

V6-00965, Article No. 453784

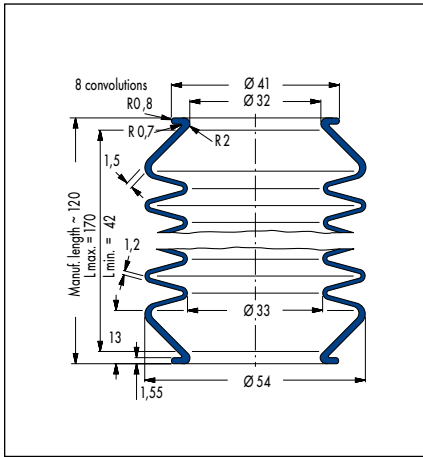

V6-00209, Article No. 439186

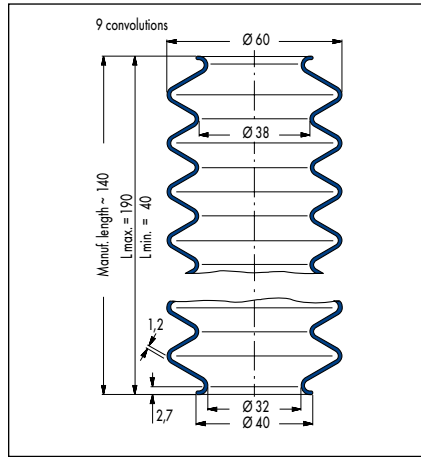

V6-00407, Article No. 428832

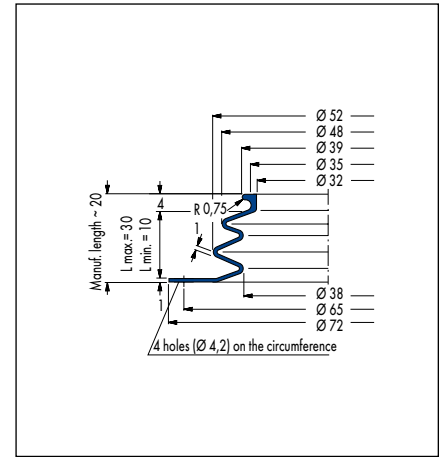

V6-00736, Article No. 426374

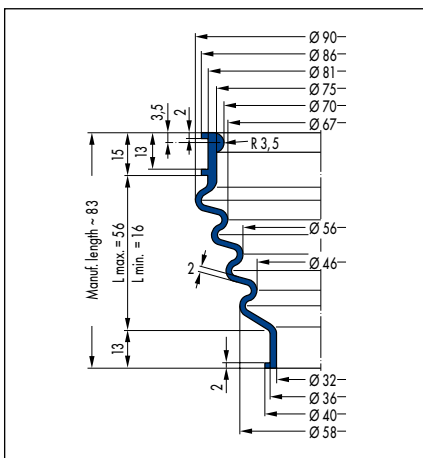

V6-01431, Article No. 454267

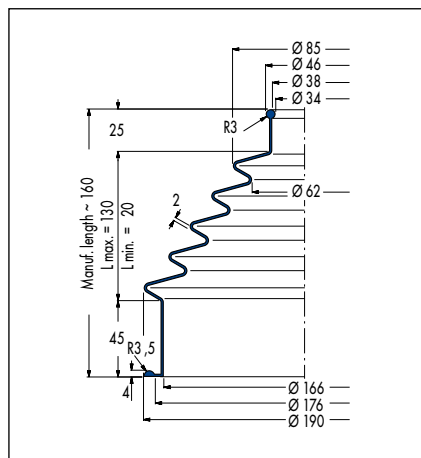

V6-00925, Article No. 454474

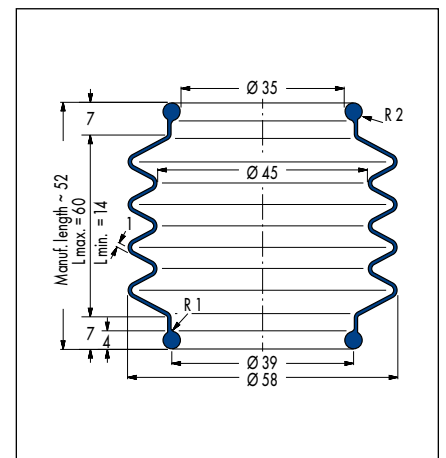

V6-00659, Article No. 424147

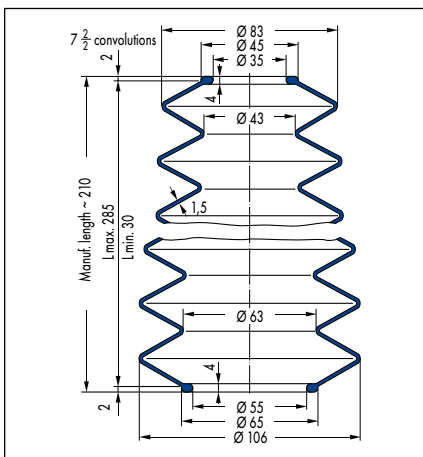

V6-00652, Article No. 457563

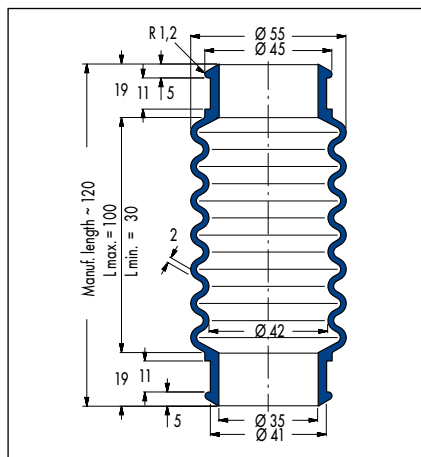

V6-00281, Article No. 427264

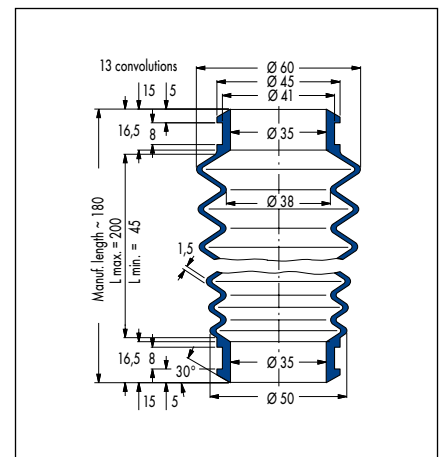

V6-00266, Article No. 429647

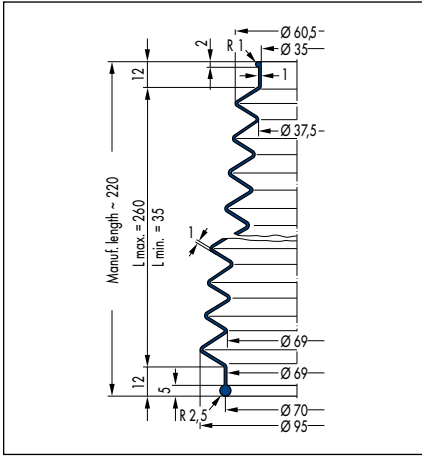

V6-01080, Article No. 457509

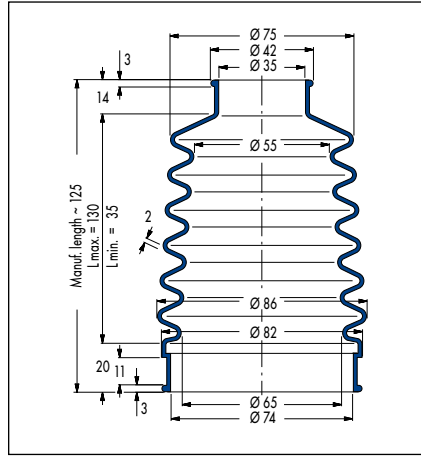

V6-00654, Article No. 49312608

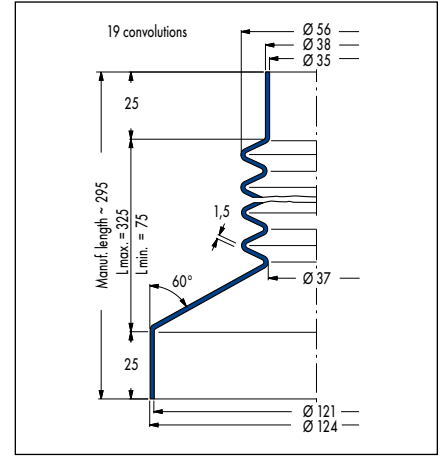

V6-00117, Article No. 29288

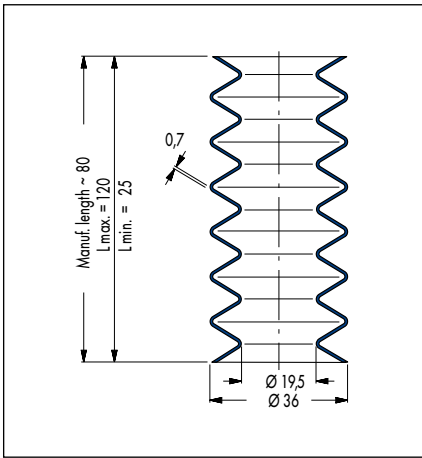

V6-00053, Article No. 435517

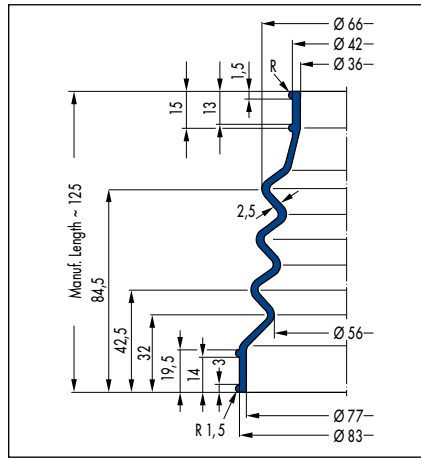

V6-01449, Article No. 152544

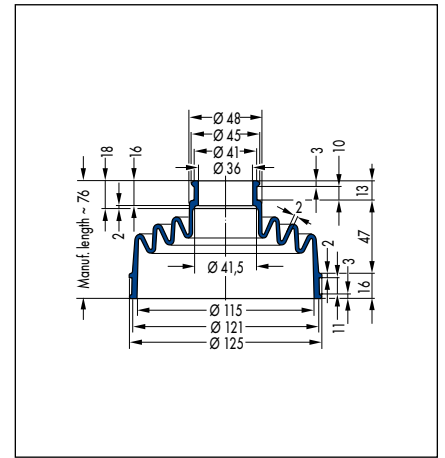

V6-00419, Article No. 507686

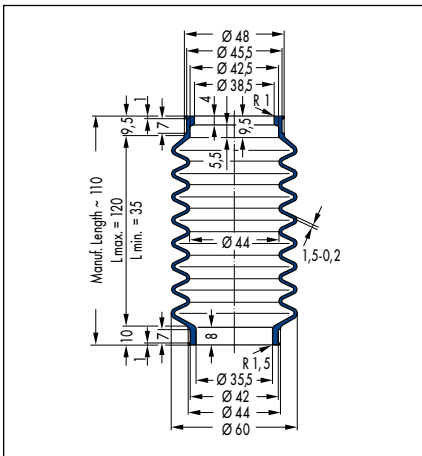

V6-00204, Article No. 439168

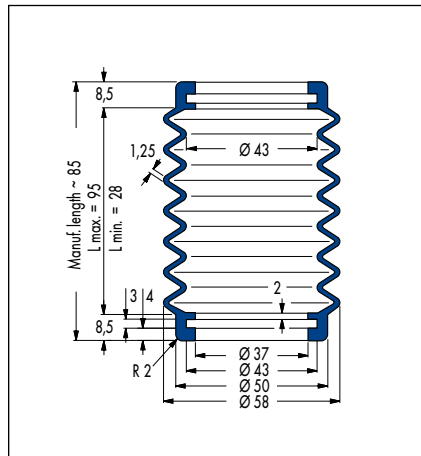

V6-00308, Article No. 427265

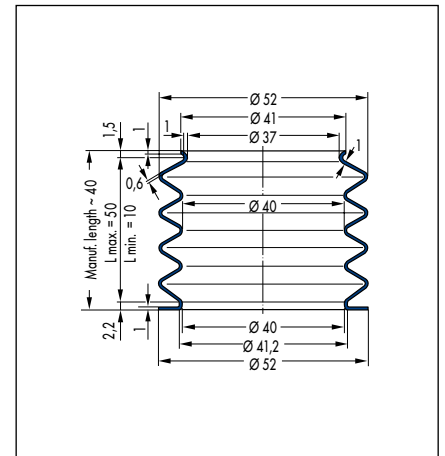

V6-00467, Article No. 456485

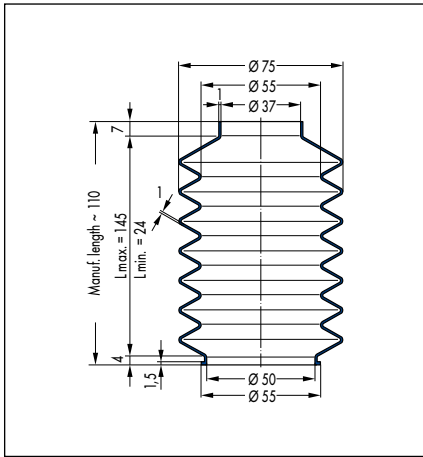

V6-00790, Article No. 29965

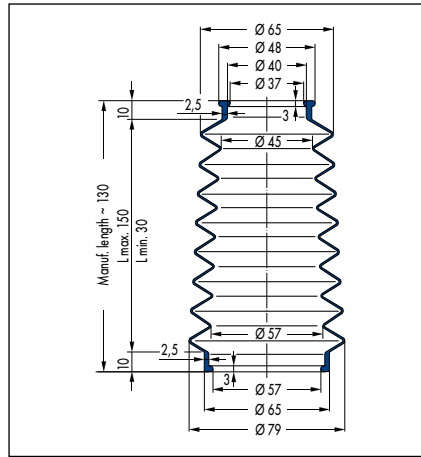

V6-00823, Article No. 400862

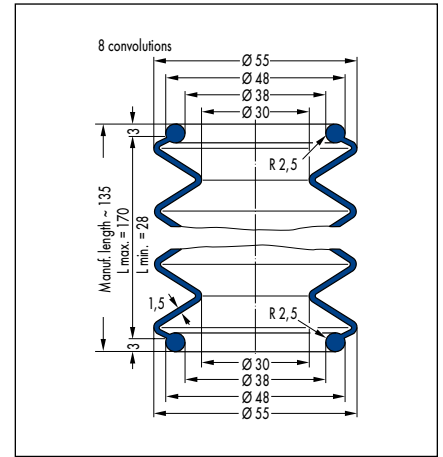

V6-00297, Article No. 501137

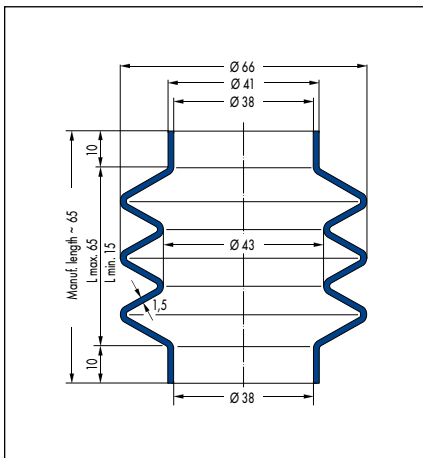

V6-00808, Article No. 439042

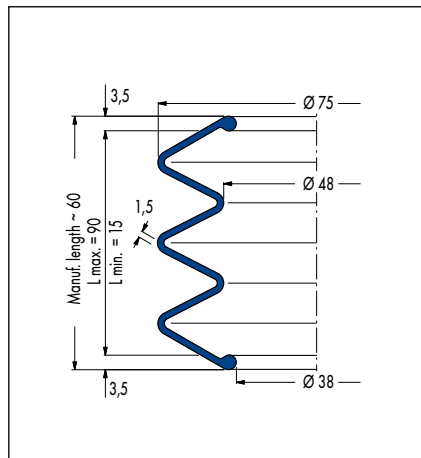

V6-00429, Article No. 431588

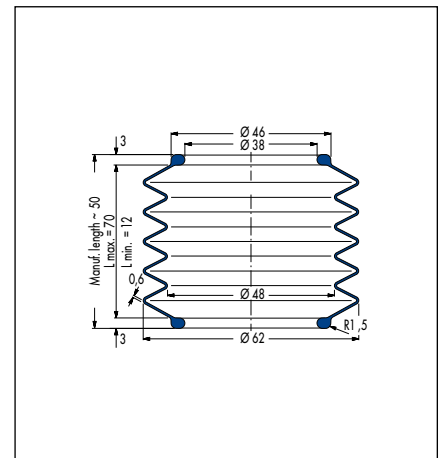

V6-00662, Article No. 49312622

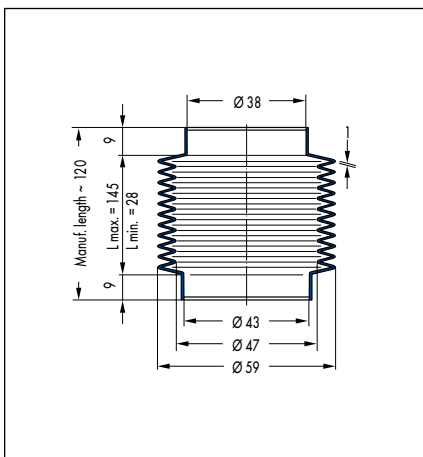

V6-00230, Article No. 439434

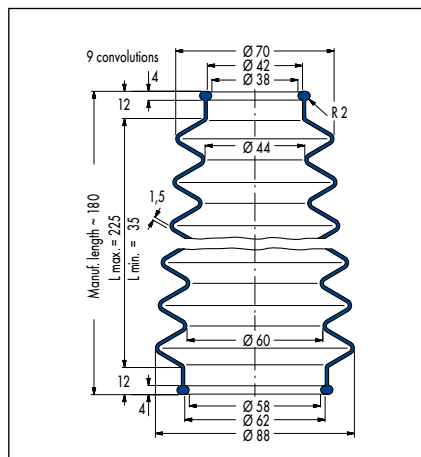

V6-00619, Article No. 431955 (CR)/  
431957 (NBR)

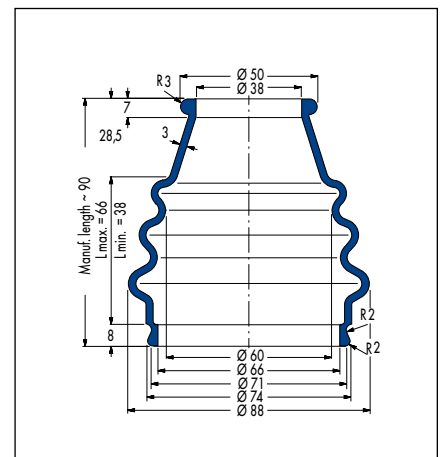

V6-00190, Article No. 438014

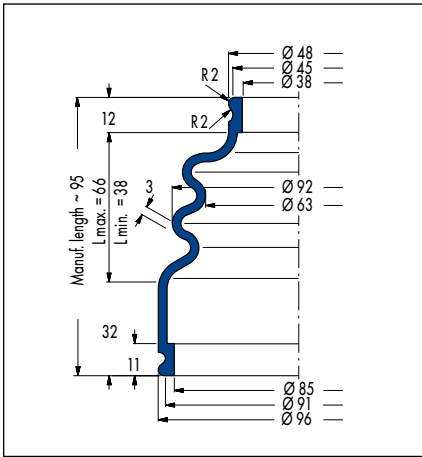

V6-00191, Article No. 428311

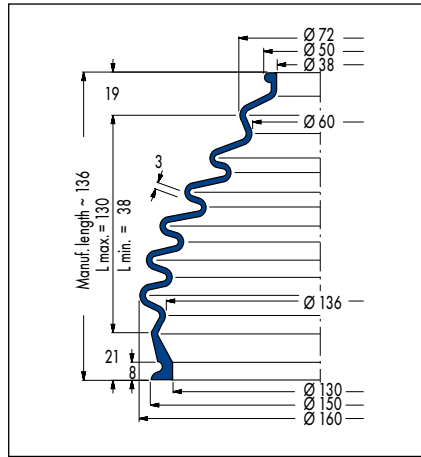

V6-00199, Article No. 438027

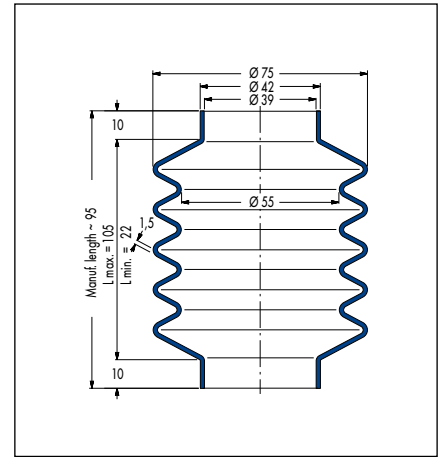

V6-00321, Article No. 429648

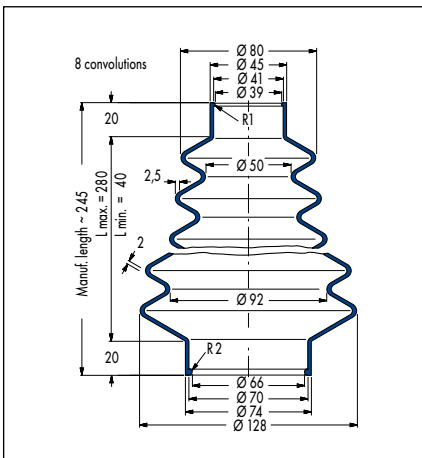

V6-00556, Article No. 29735

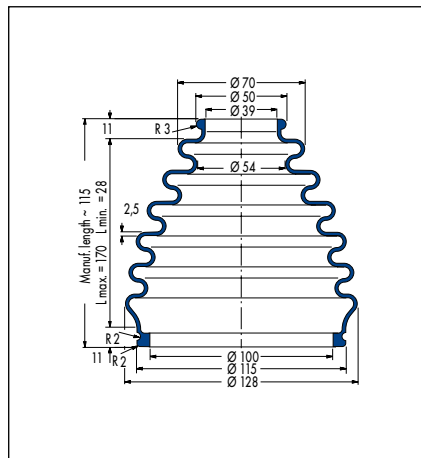

V6-00060, Article No. 428322

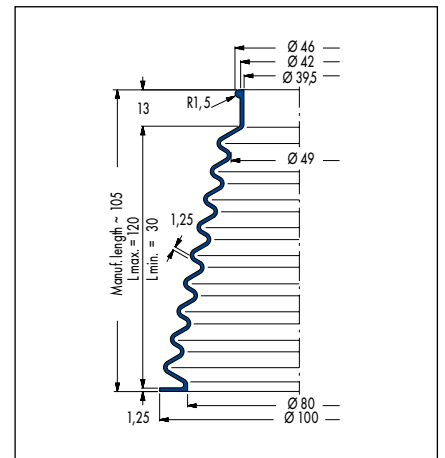

V6-00188, Article No. 49312536

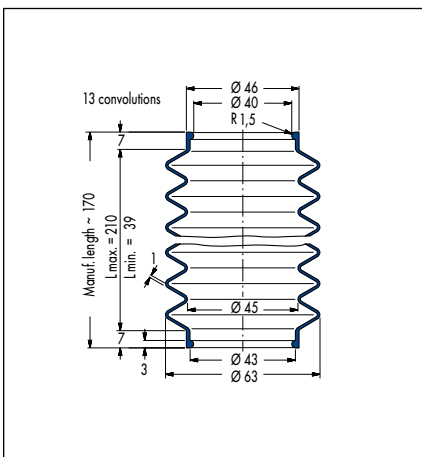

V6-00801, Article No. 438557 (50 CR 879)/  
440760 (42 CR 764)

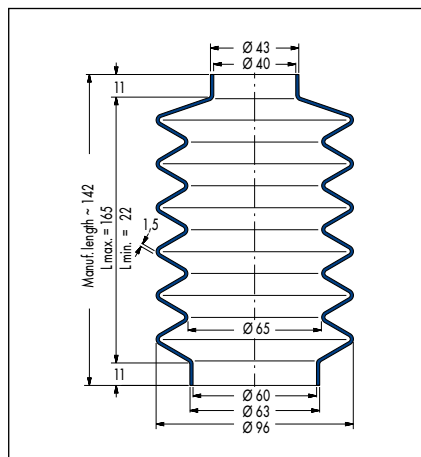

V6-00072, Article No. 434088

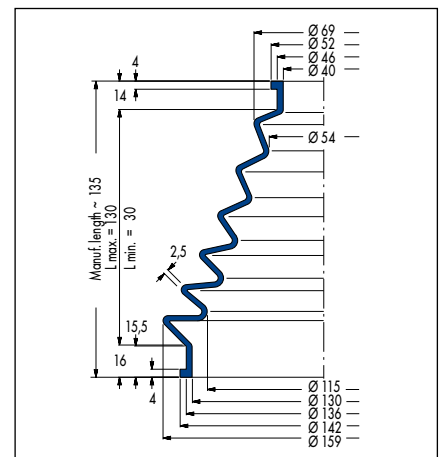

V6-00092, Article No. 434425



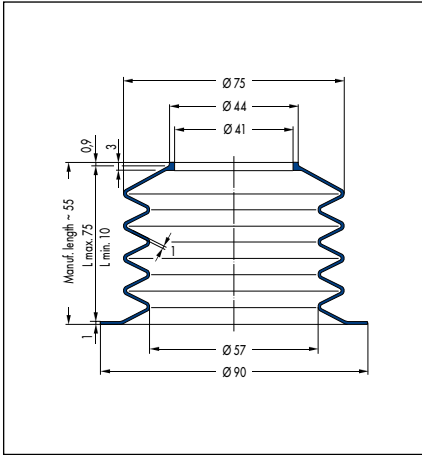

V6-00700, Article No. 153008

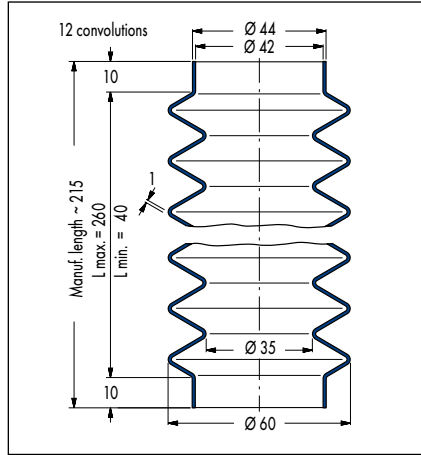

V6-00637, Article No. 438549

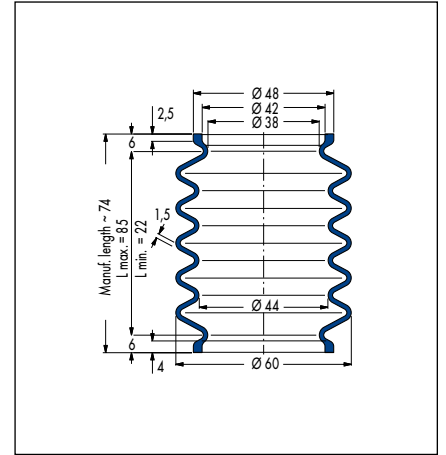

V6-00268, Article No. 432119

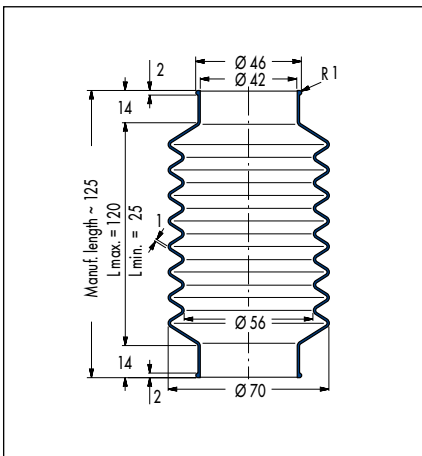

V6-00536, Article No. 426801

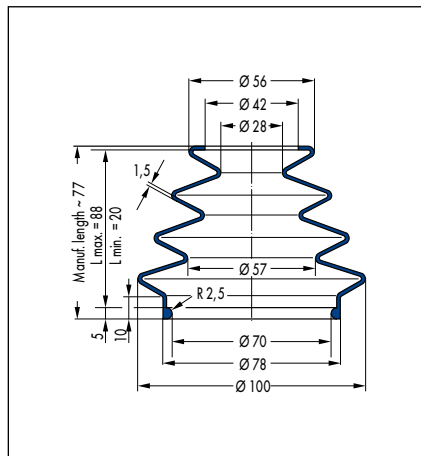

V6-20195, Article No. 501096

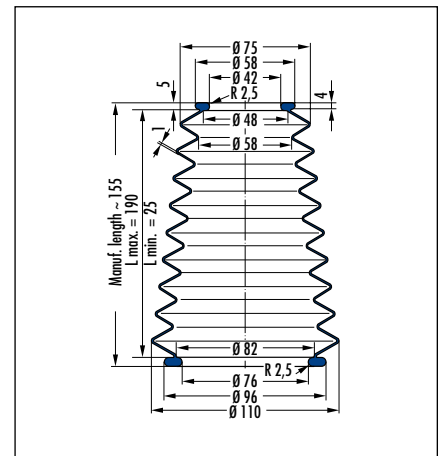

V6-00328, Article No. 432424 (42 CR 764)/  
454213 (50 CR 879)

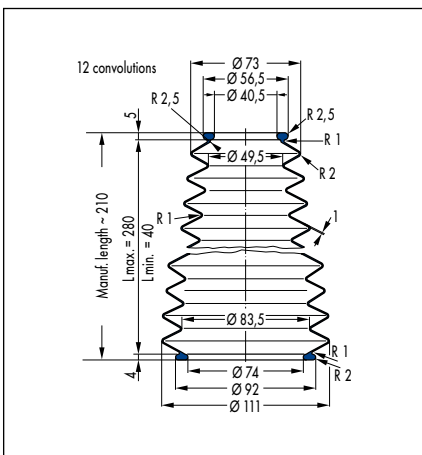

V6-00562, Article No. 29741

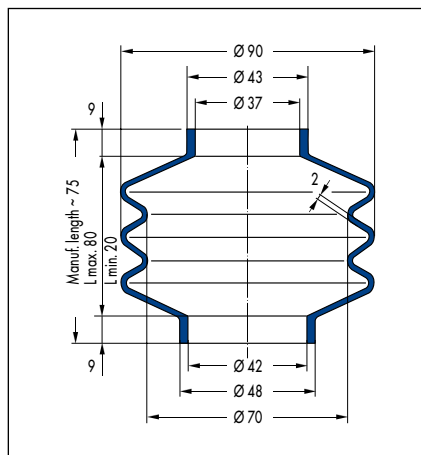

V6-01030, Article No. 400918

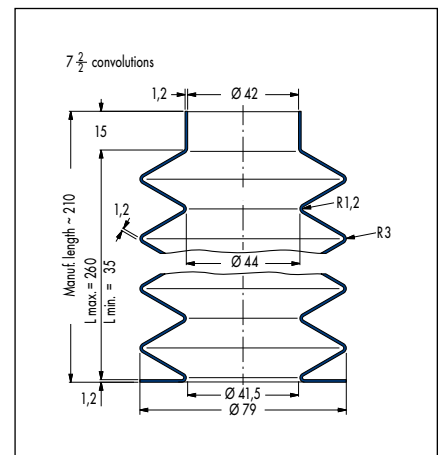

V6-00626, Article No. 437270

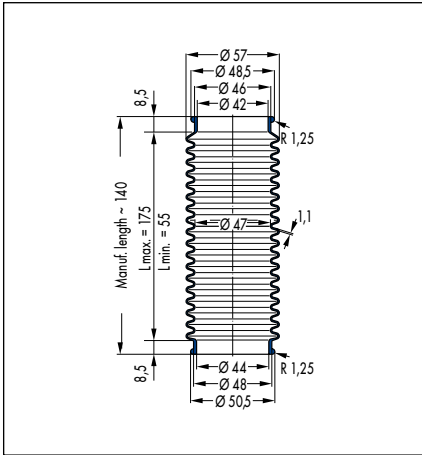

V6-00449, Article No. 456484

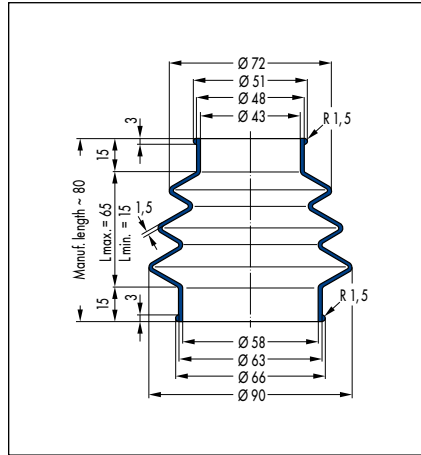

V6-00853, Article No. 465751

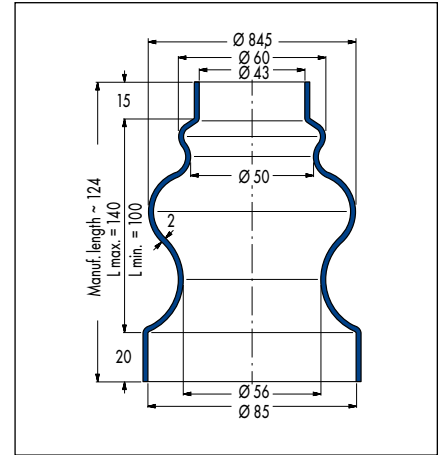

V6-00012, Article No. 426317 (42 CR 764)/  
60032051 (45 NBR 670)

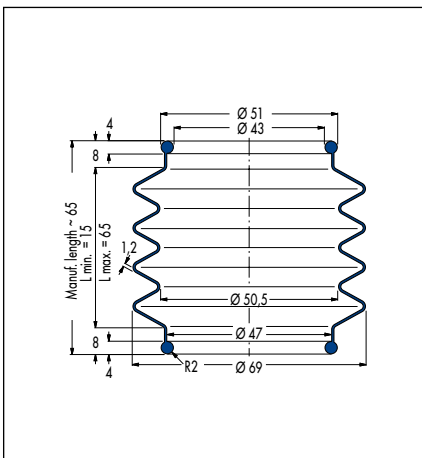

V6-00784, Article No. 432192

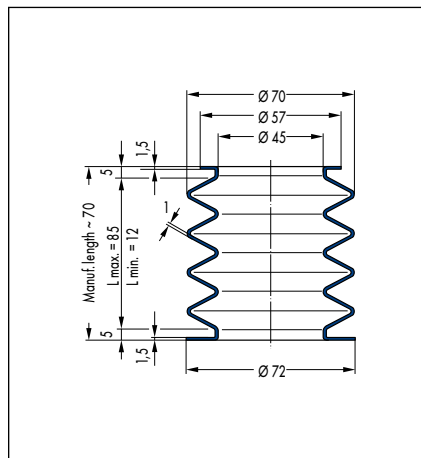

V6-00967, Article No. 89513

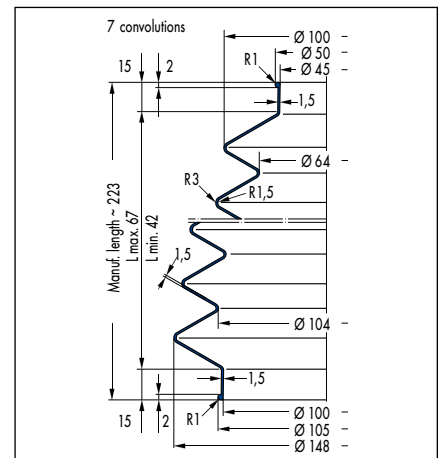

V6-01046, Article No. 400920

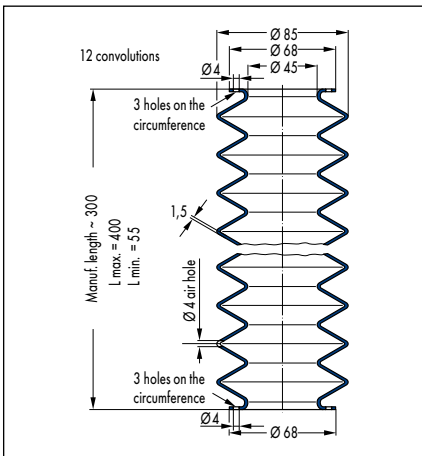

V6-01075, Article No. 400934

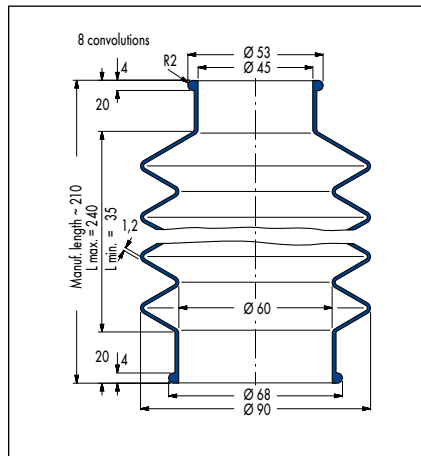

V6-00593, Article No. 439497 (42 CR 764)/  
439499 (50 CR 879)

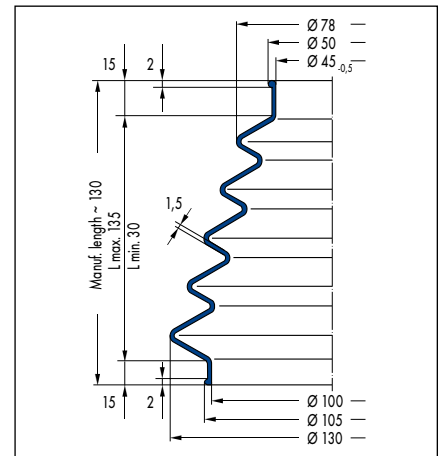

V6-01047, Article No. 454226

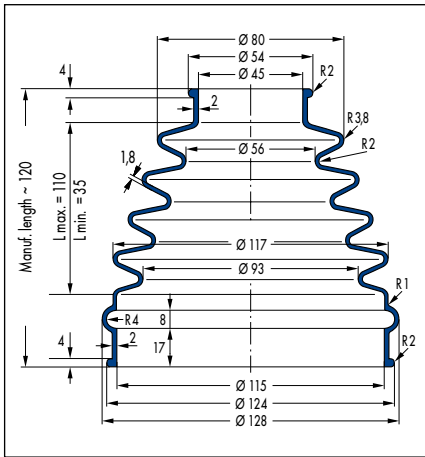

V6-00507, Article No. 452565

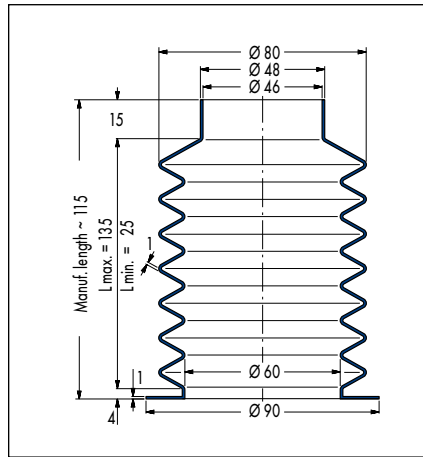

V6-00466, Article No. 430847

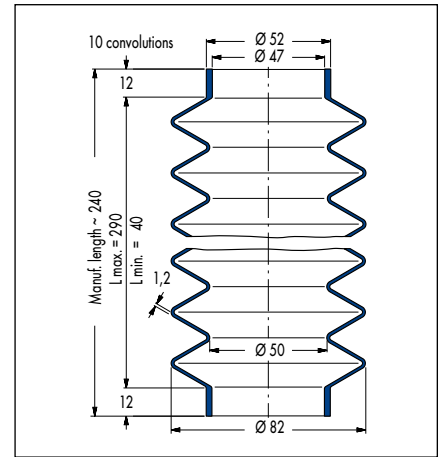

V6-01022, Article No. 49344567 (CR)/  
49344592 (NBR)

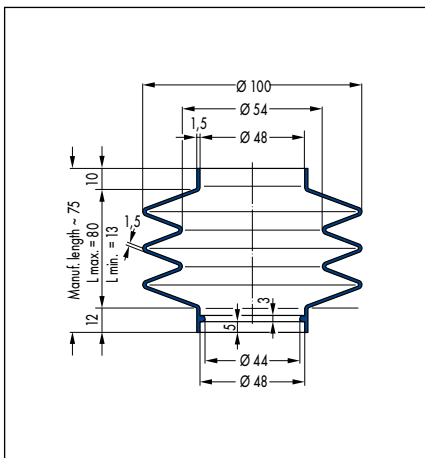

V6-01136, Article No. 425266

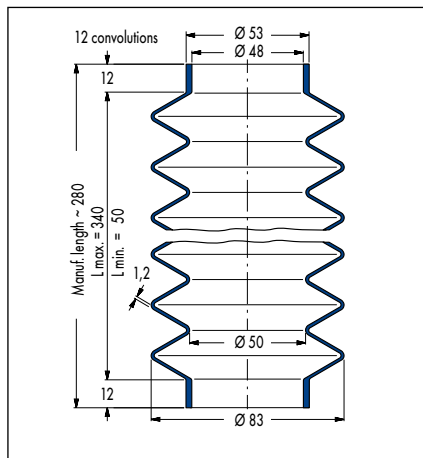

V6-01165, Article No. 454248

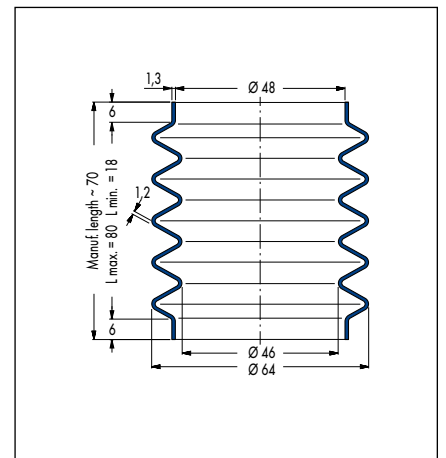

V6-00541, Article No. 25105

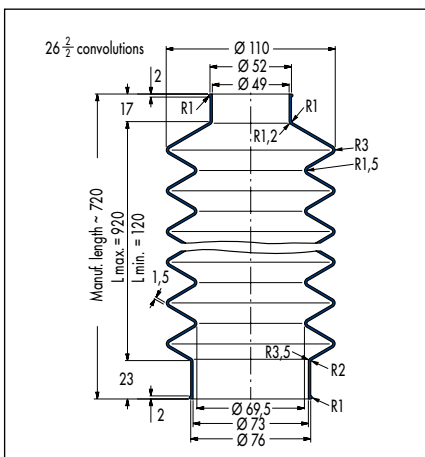

V6-00723, Article No. 29915

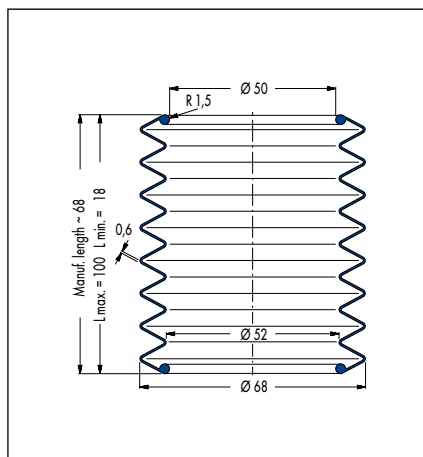

V6-00742, Article No. 426388

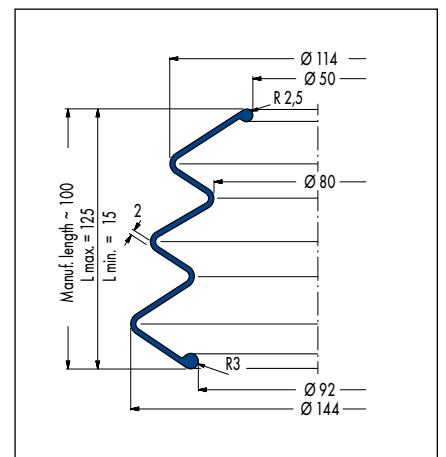

V6-00821, Article No. 25235

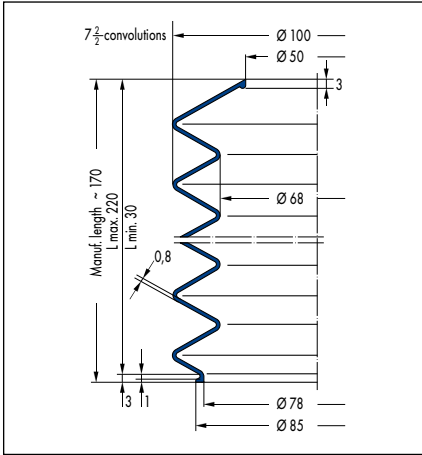

V6-01029, Article No. 20231

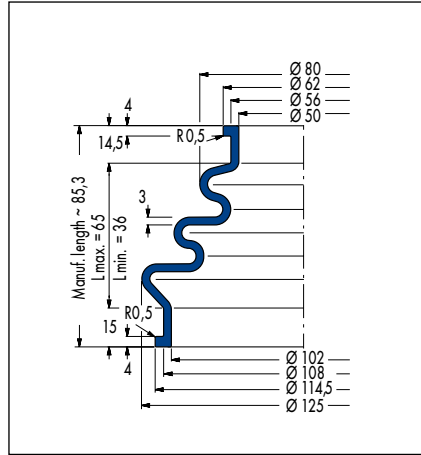

V6-00091, Article No. 456482

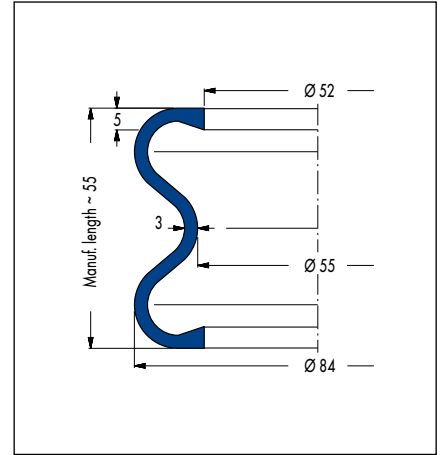

V6-00291, Article No. 440381

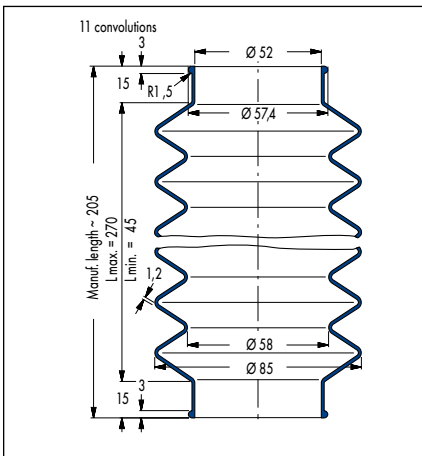

V6-00987, Article No. 49312666 (42 CR 764)/  
49312659 (50 CR 879)

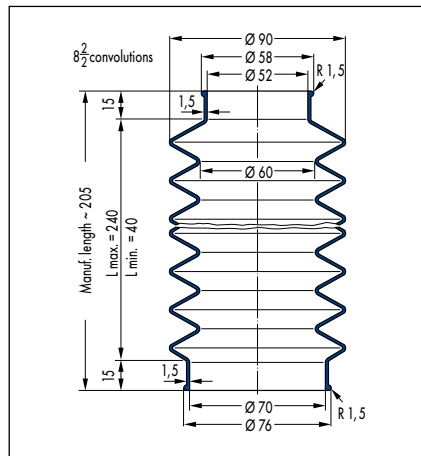

V6-00976, Article No. 429665

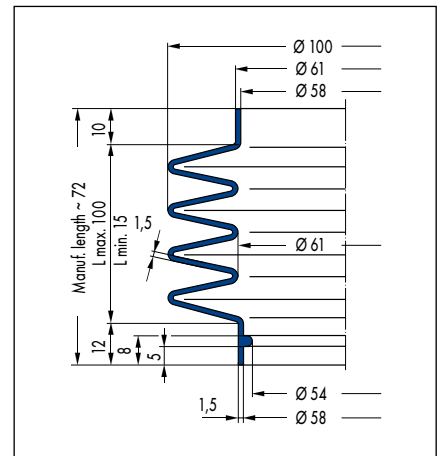

V6-01064, Article No. 453735

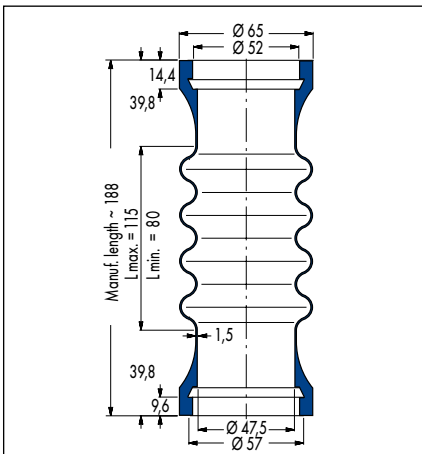

V6-00226, Article No. 439437

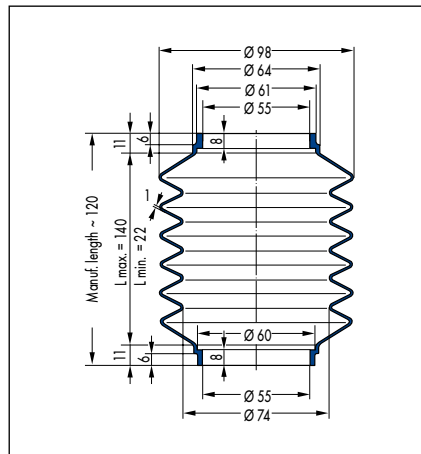

V6-00577, Article No. 439496

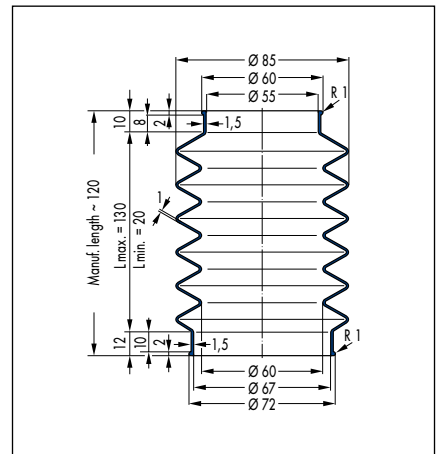

V6-00740, Article No. 430860

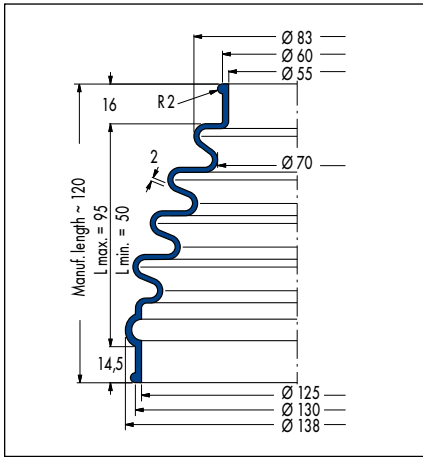

V6-00205, Article No. 440285

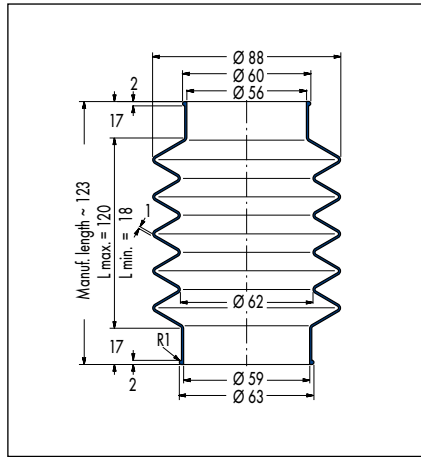

V6-00153, Article No. 426797

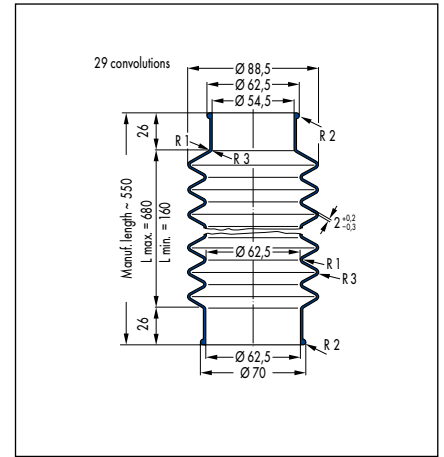

V6-00519, Article No. 29705

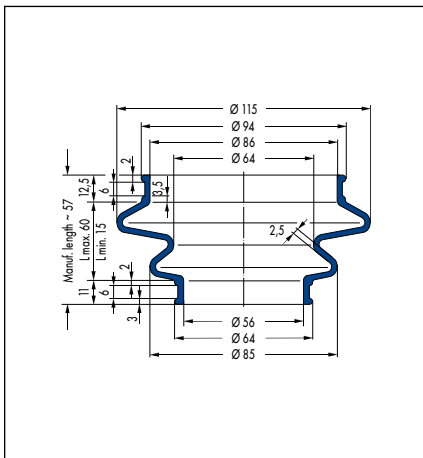

V6-00779, Article No. 360138

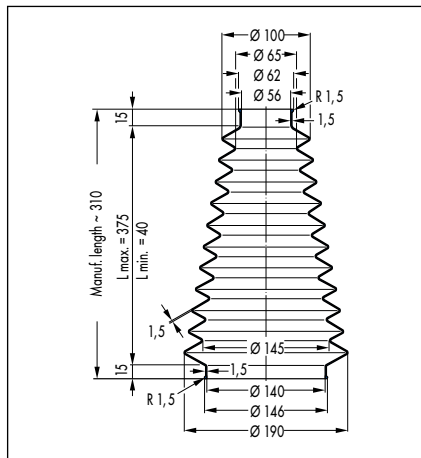

V6-00926, Article No. 35807

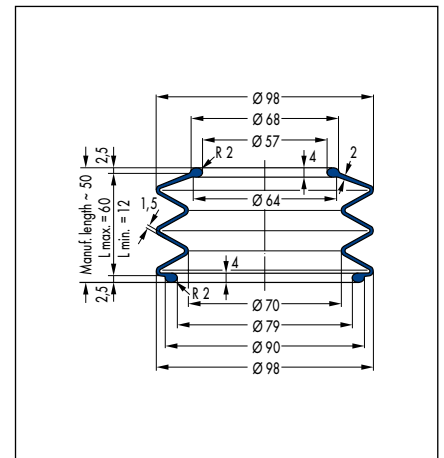

V6-01226, Article No. 452566

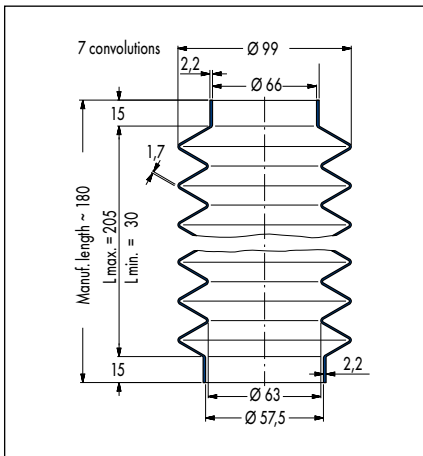

V6-00375, Article No. 428321

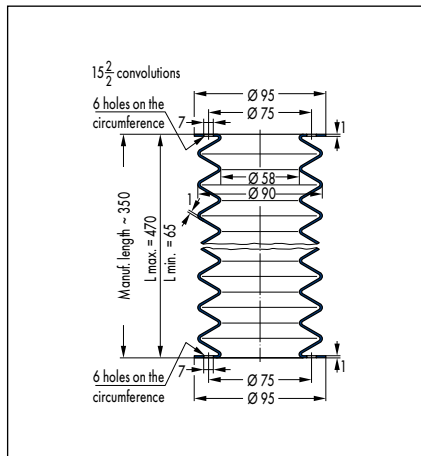

V6-00606, Article No. 29774

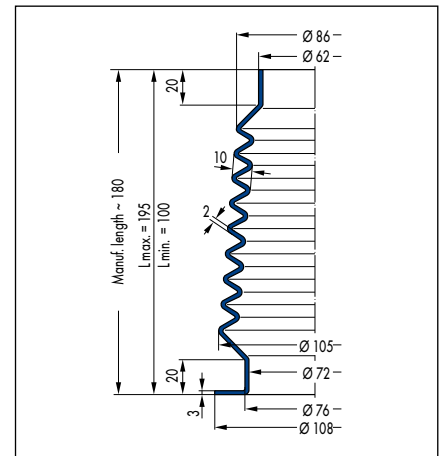

V6-00866, Article No. 454218

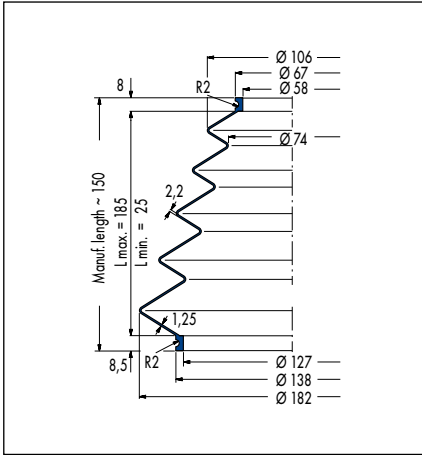

V6-00352, Article No. 19577

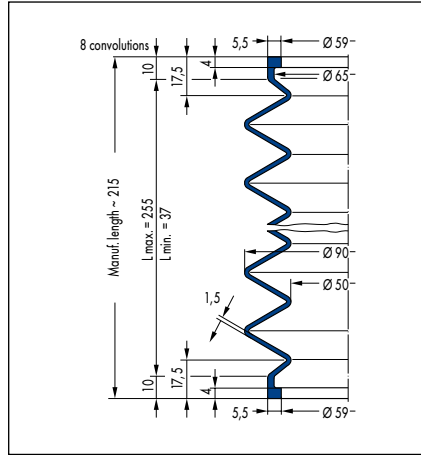

V6-00937, Article No. 60022627

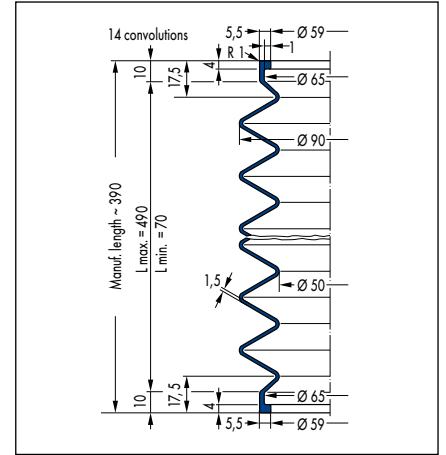

V6-00910, Article No. 103132

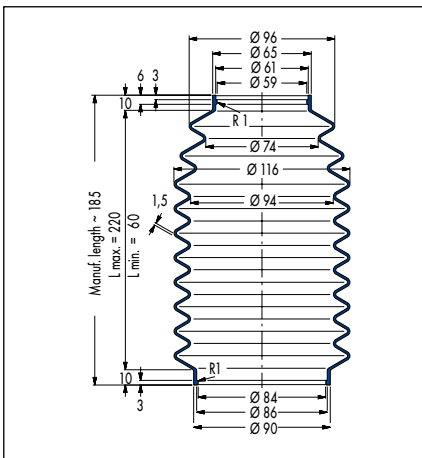

V6-01453, Article No. 454255

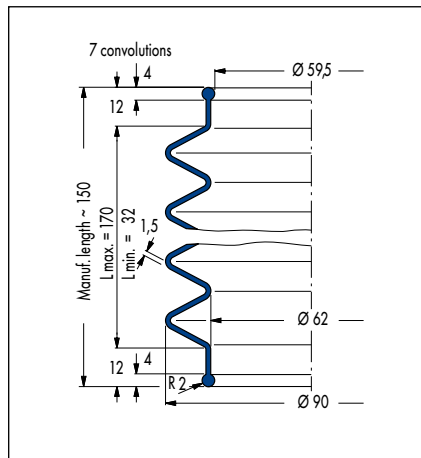

V6-00260, Article No. 434071

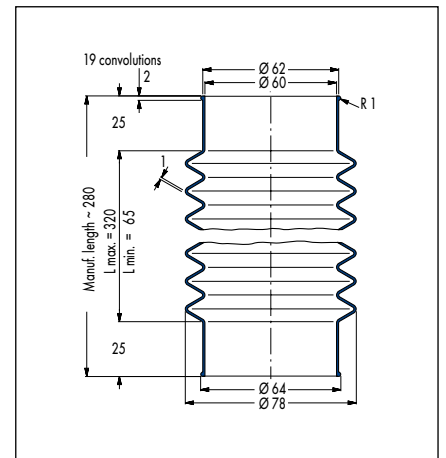

V6-00499, Article No. 49312584

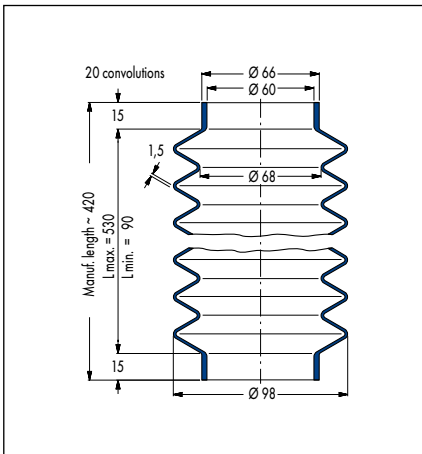

V6-00450, Article No. 29652

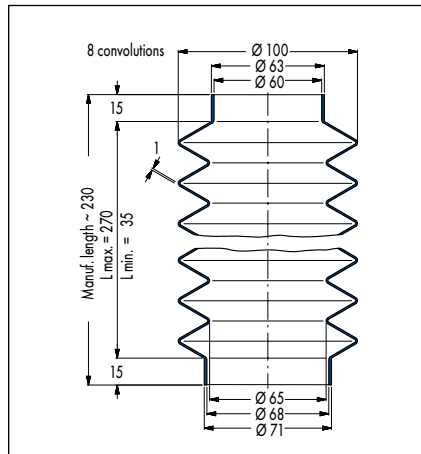

V6-00400, Article No. 438535

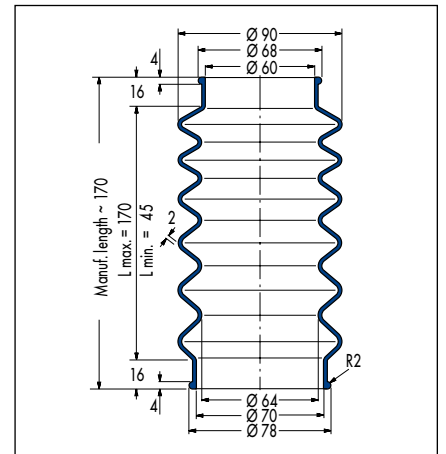

V6-00453, Article No. 426371

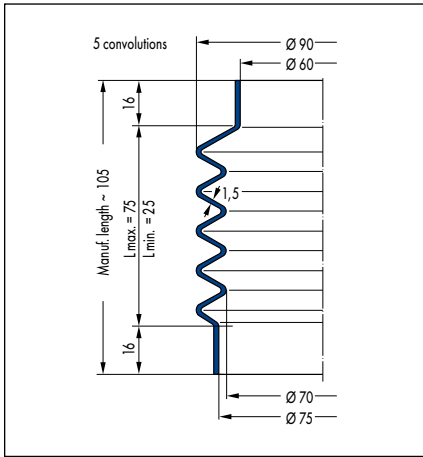

V6-01774, Article No. 49312711

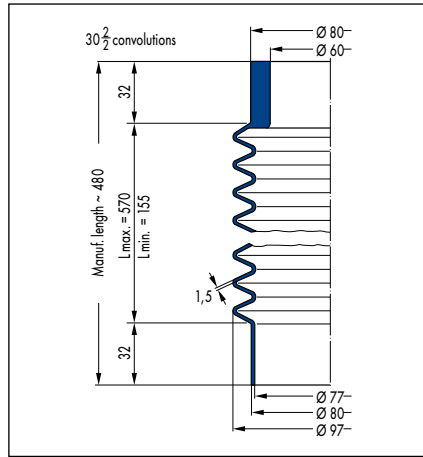

V6-01018, Article No. 454225

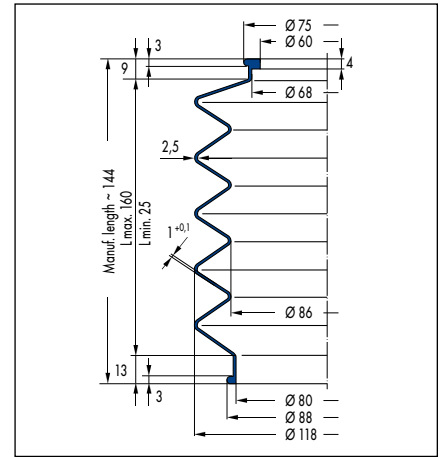

V6-01049, Article No. 454227

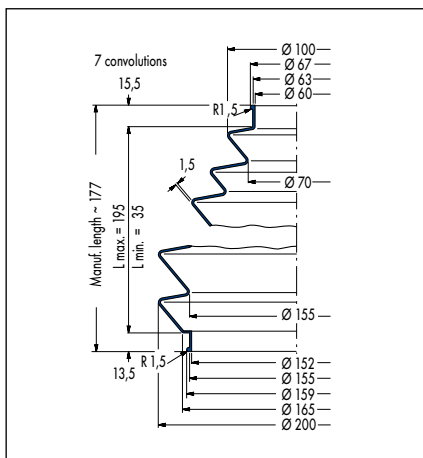

V6-00444, Article No. 29643

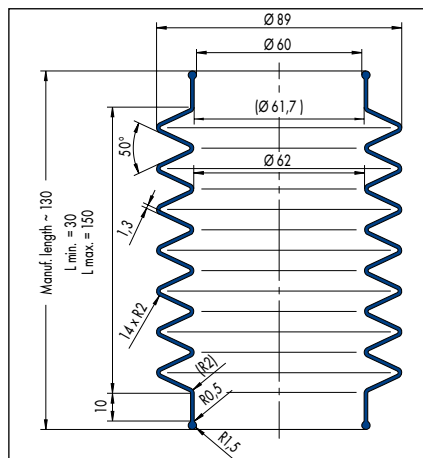

V6-20454, Article No. 49473169

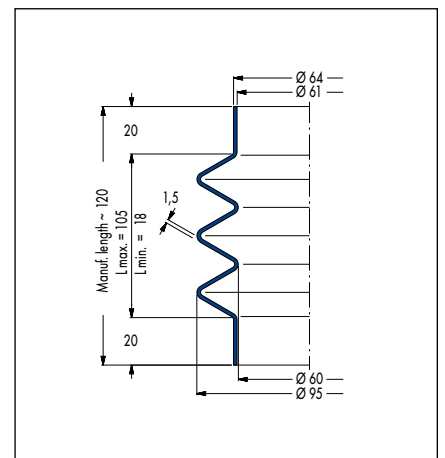

V6-00099, Article No. 434091 (NBR)/  
434092 (CR)

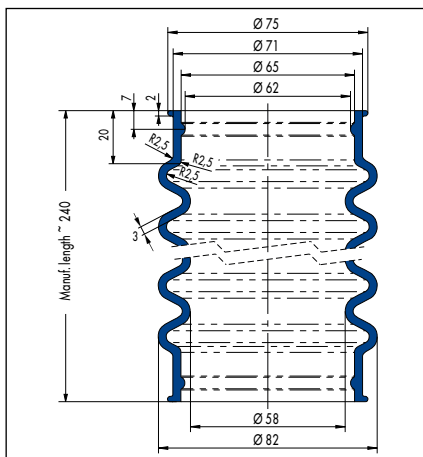

V6-20082, Article No. 49469781

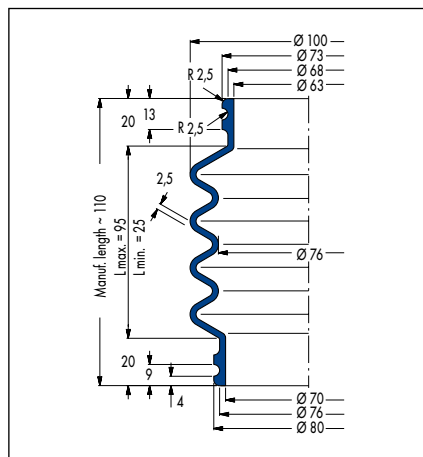

V6-00242, Article No. 439438

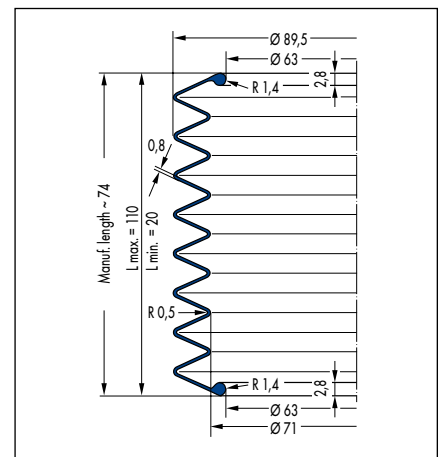

V6-00743, Article No. 25159 (CR)/  
501518 (NBR)





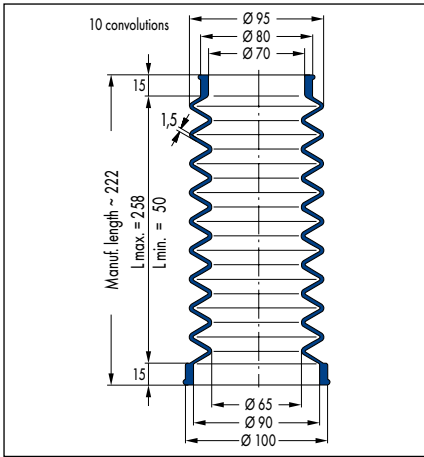

V6-20173, Article No. 458302

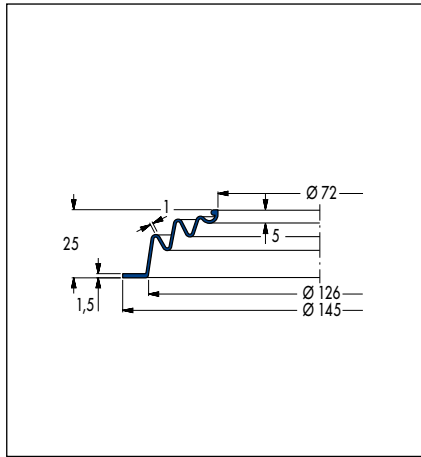

V6-00441, Article No. 434020

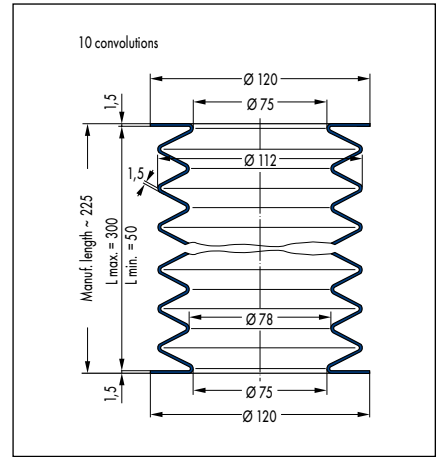

V6-00813, Article No. 414718

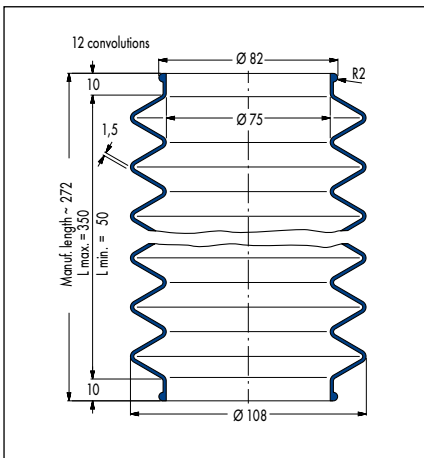

V6-00093, Article No. 440343 (CR)/  
440342 (NBR)

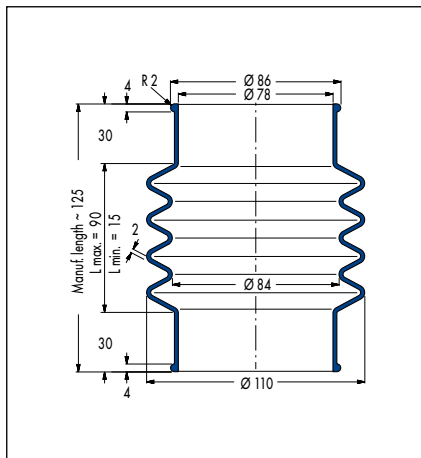

V6-00501, Article No. 438944 (50 CR 879)/  
438946 (42 CR 764)

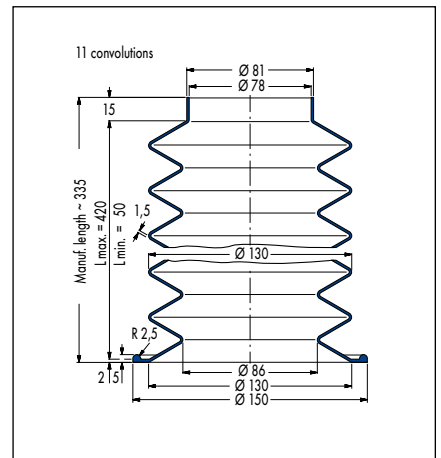

V6-00520, Article No. 25100 (45 NBR 670)/  
307731 (50 CR 879)

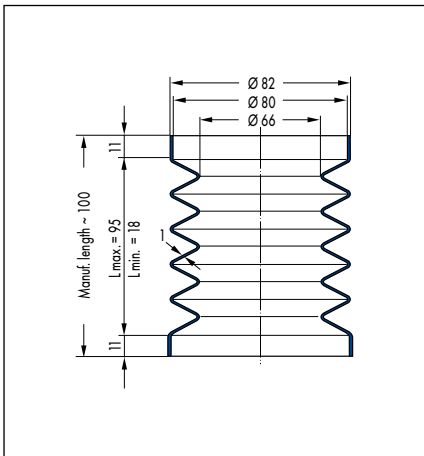

V6-00141, Article No. 451746 (42 CR 764)/  
451747 (50 CR 879)

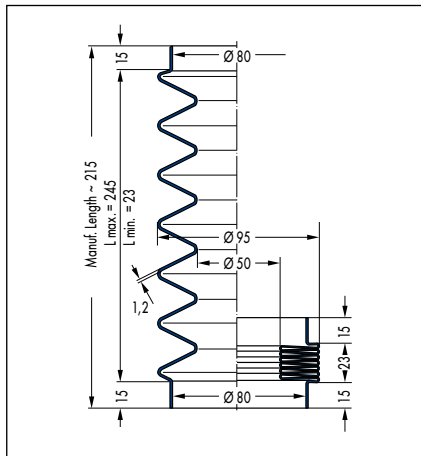

V6-00115, Article No. 29283

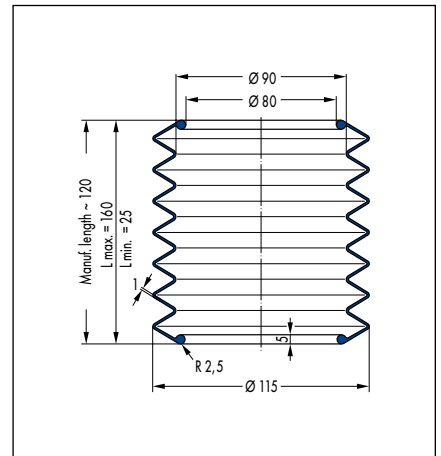

V6-01079, Article No. 454232

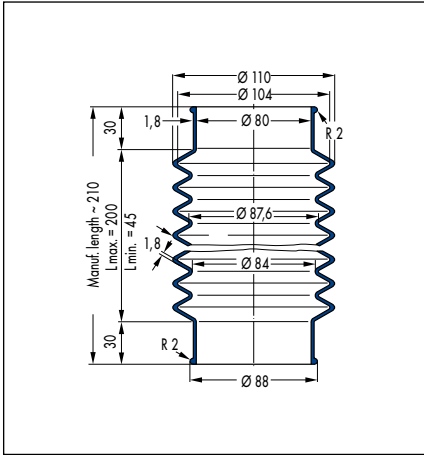

V6-00476, Article No. 61279

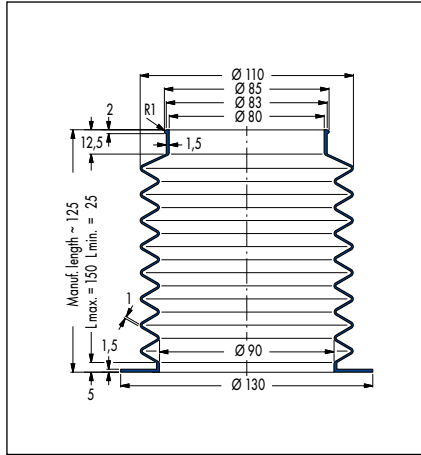

V6-00963, Article No. 454221

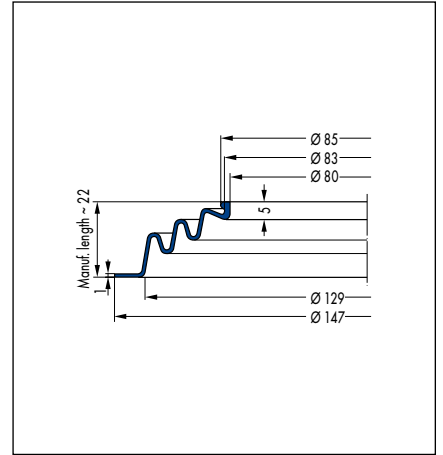

V6-00846, Article No. 307856

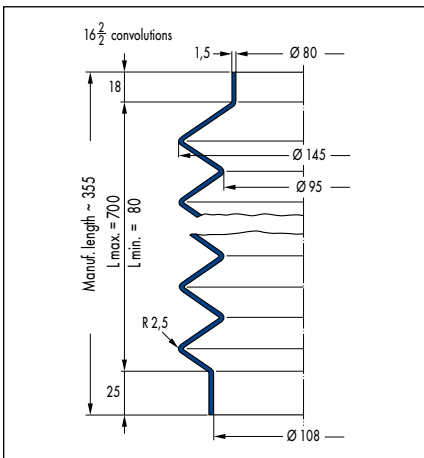

V6-00455, Article No. 29660

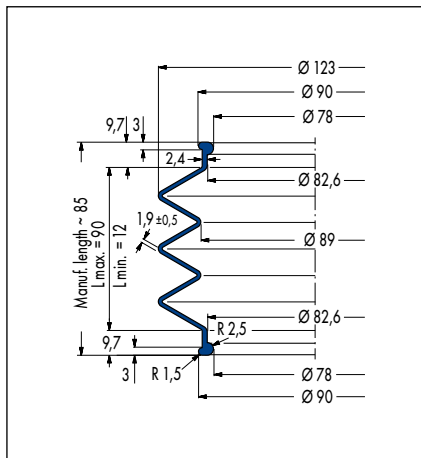

V6-00633, Article No. 426324

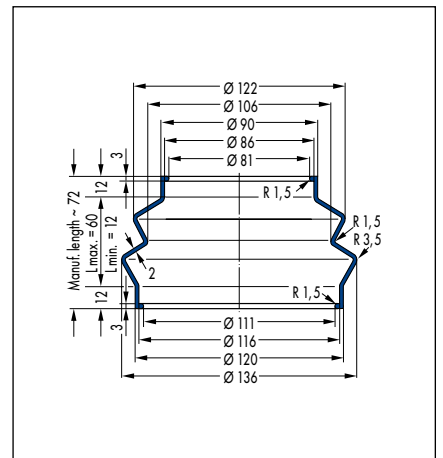

V6-00326, Article No. 454212

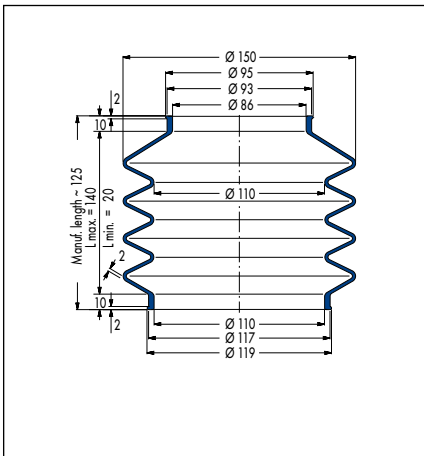

V6-00643, Article No. 29807 (CR)/  
49057942 (NBR)

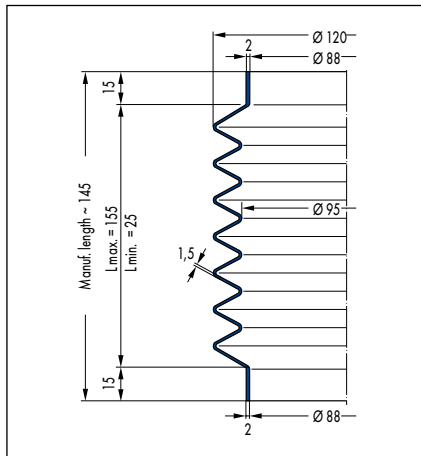

V6-01261, Article No. 454481 (CR)/  
454480 (NBR)

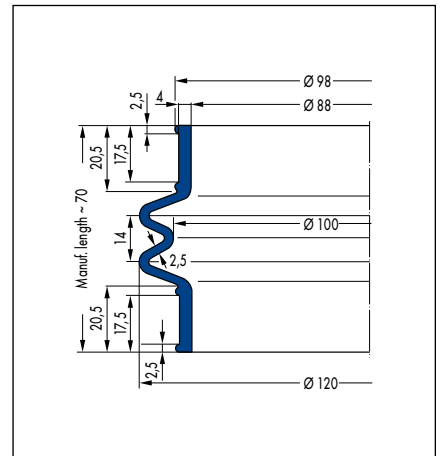

V6-01412, Article No. 104484

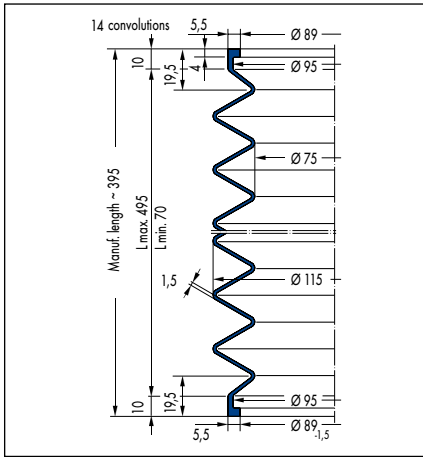

V6-00911, Article No. 63487

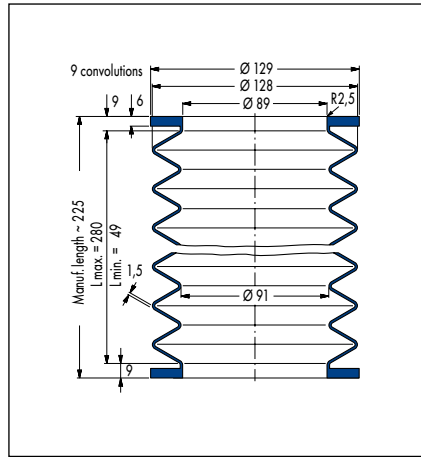

V6-00721, Article No. 29912

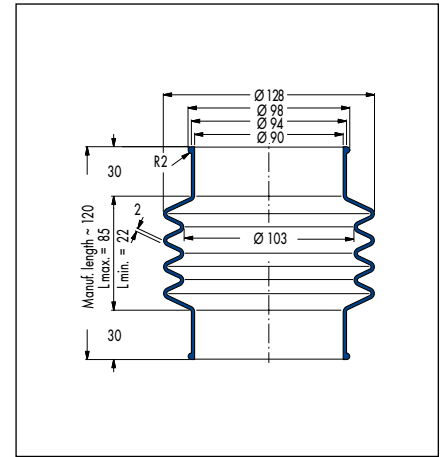

V6-00517, Article No. 454473

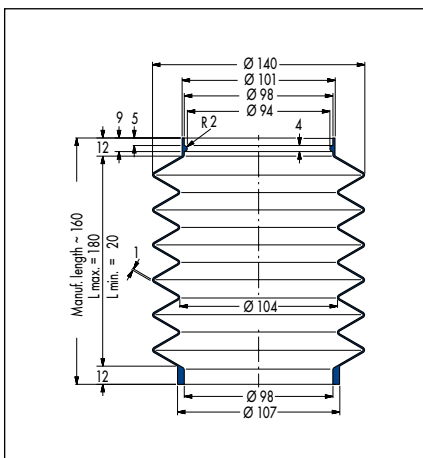

V6-01140, Article No. 454240

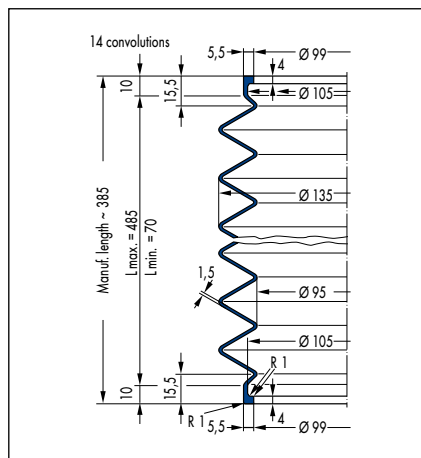

V6-00909, Article No. 505424

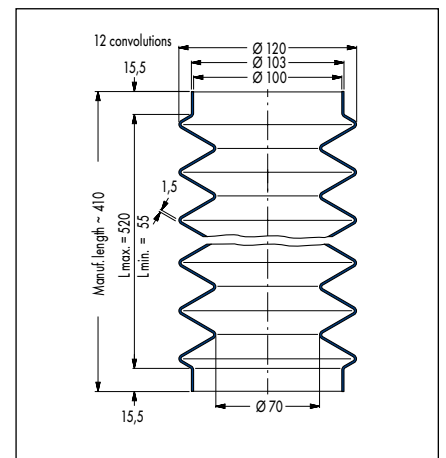

V6-00468, Article No. 29675

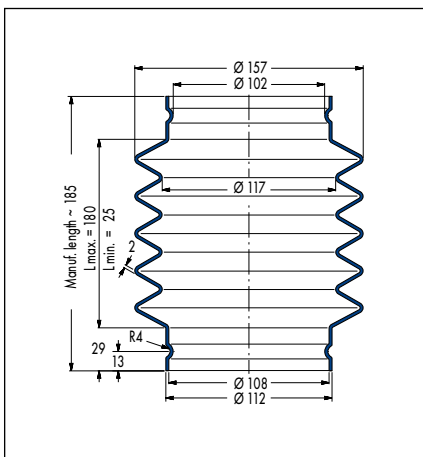

V6-00658, Article No. 25144 (CR)/  
368633 (NBR)

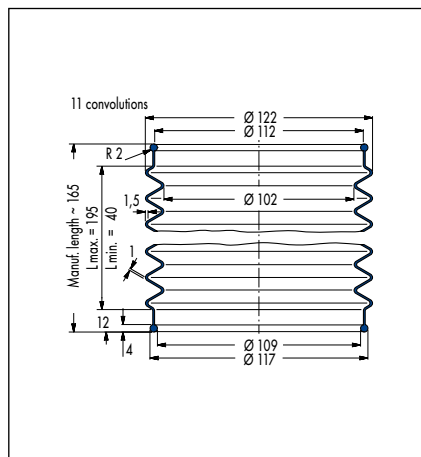

V6-00332, Article No. 454470 (CR)/  
49040057 (NBR)

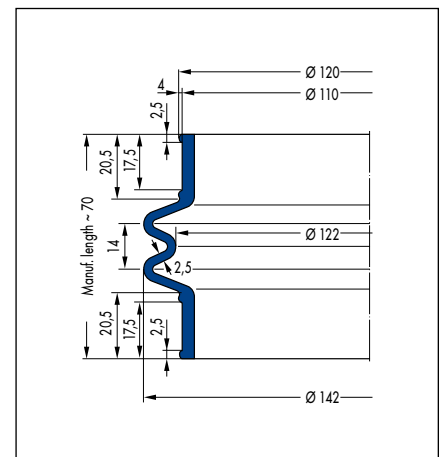

V6-01406, Article No. 333285

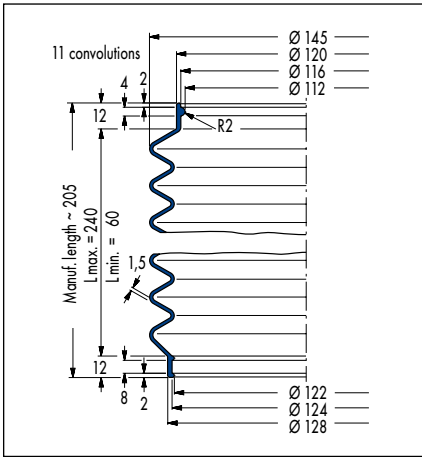

V6-01247, Article No. 454251

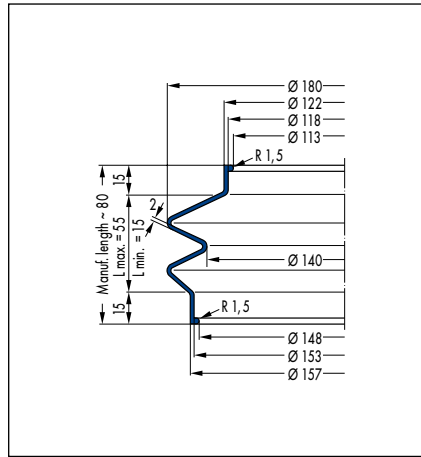

V6-00443, Article No. 1065

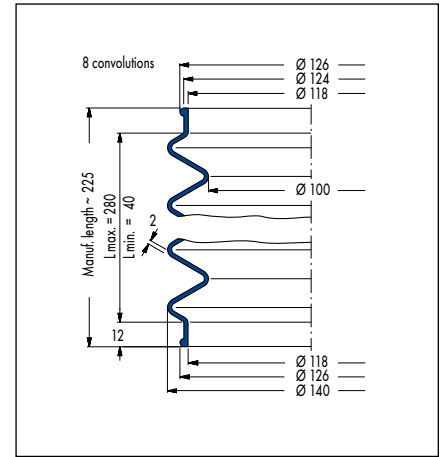

V6-00642, Article No. 2708

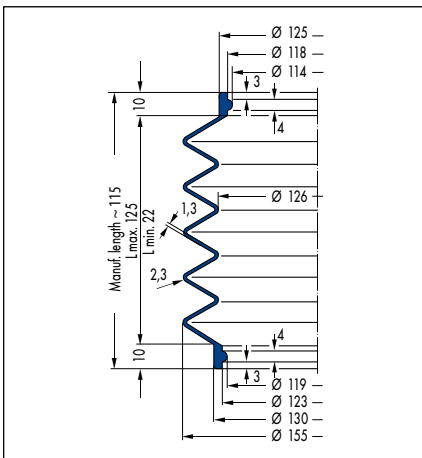

V6-01003, Article No. 454224

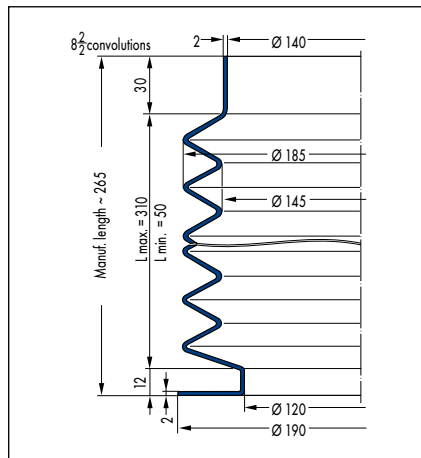

V6-00542, Article No. 125325

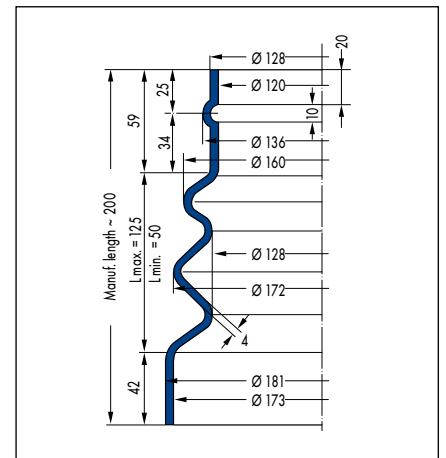

V6-00493, Article No. 23442

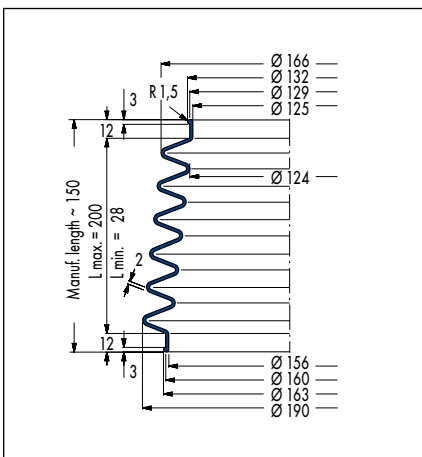

V6-00217, Article No. 29370

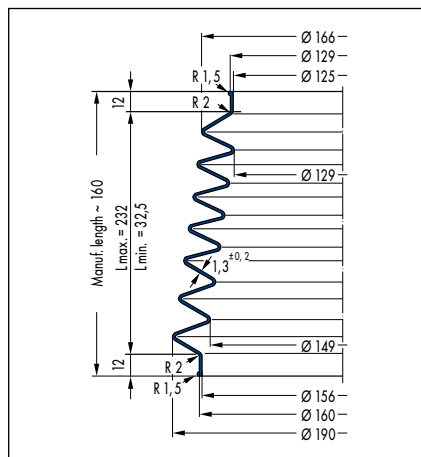

V6-01445, Article No. 355400

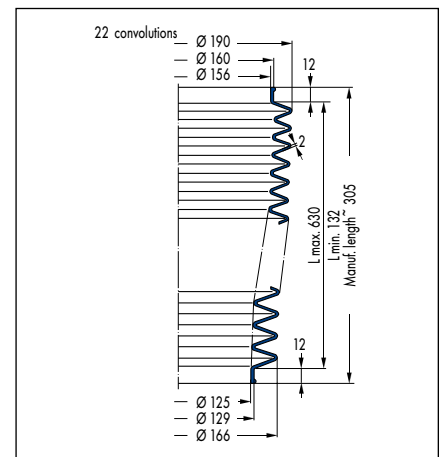

V6-01444, Article No. 60040372

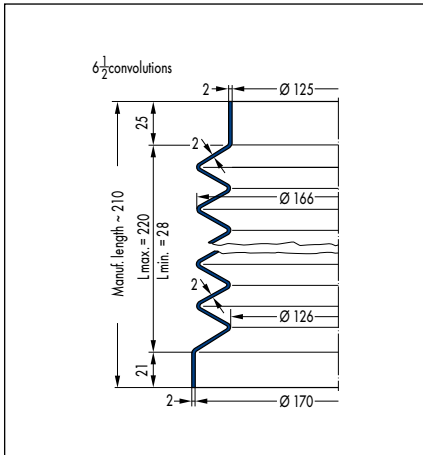

V6-00544, Article No. 29726

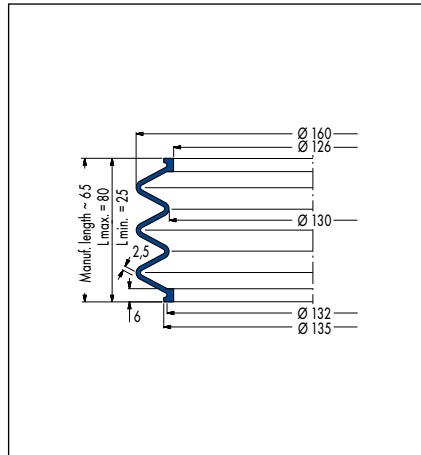

V6-00396, Article No. 454471

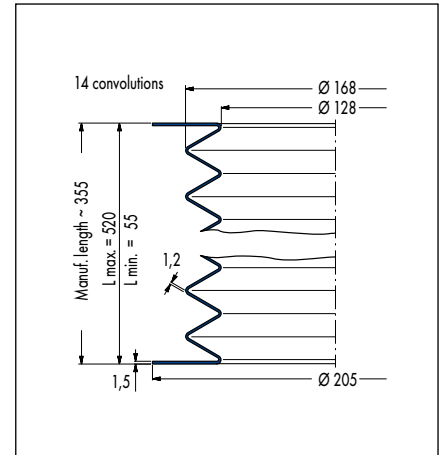

V6-00628, Article No. 29793

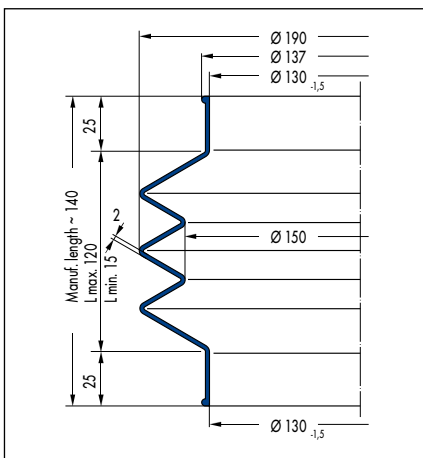

V6-01305, Article No. 400958

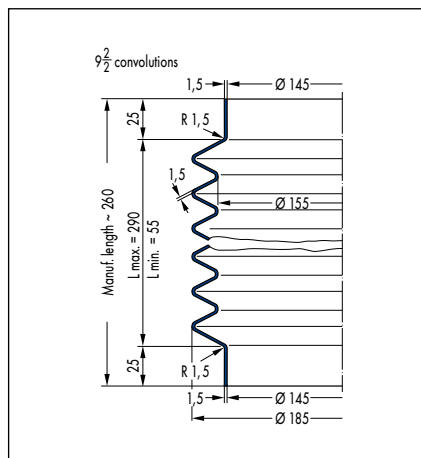

V6-00612, Article No. 29778

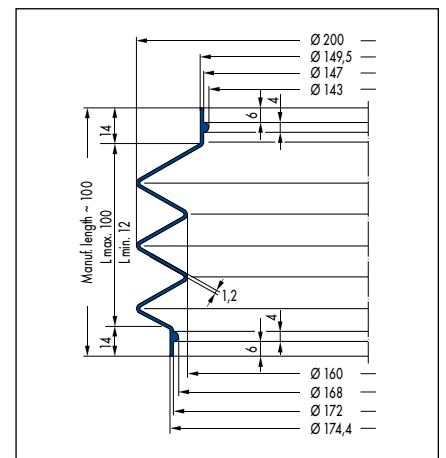

V6-00717, Article No. 505499

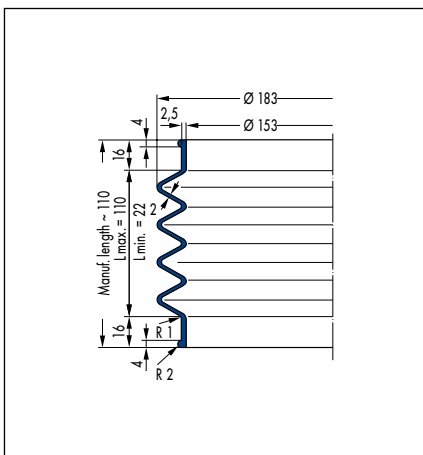

V6-00349, Article No. 423911

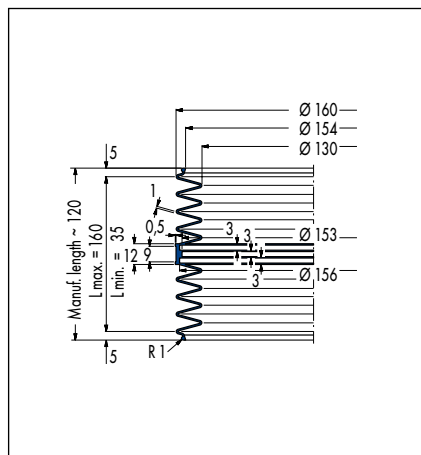

V6-00250, Article No. 29416

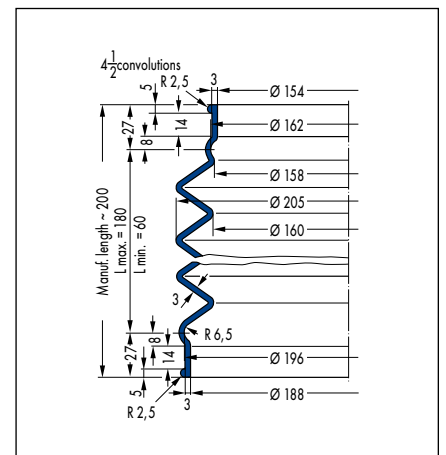

V6-00330, Article No. 325674

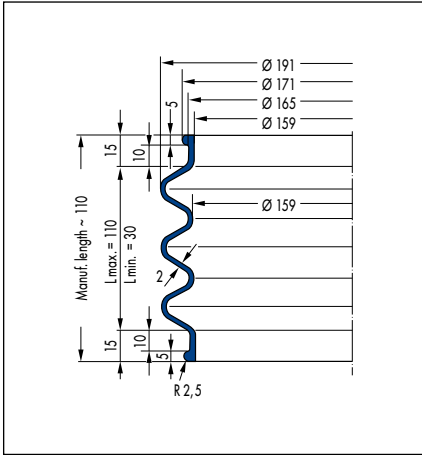

V6-00420, Article No. 29612

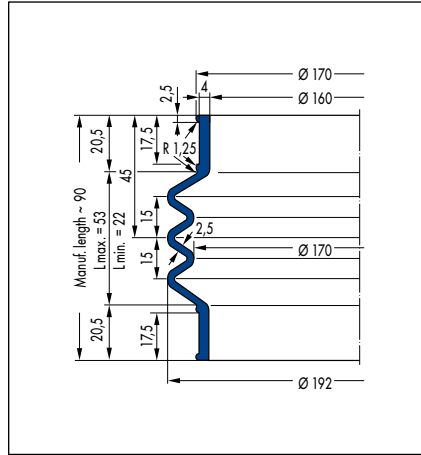

V6-01413, Article No. 104556

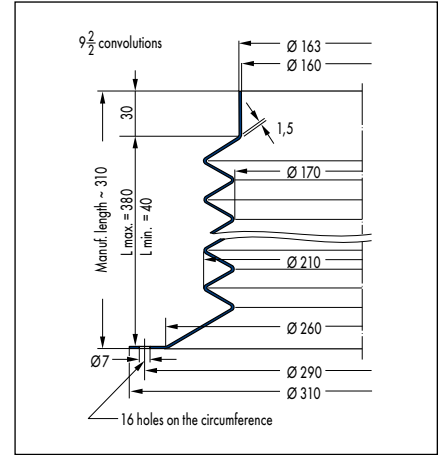

V6-00676, Article No. 29842 (CR)/  
60028661 (NBR)

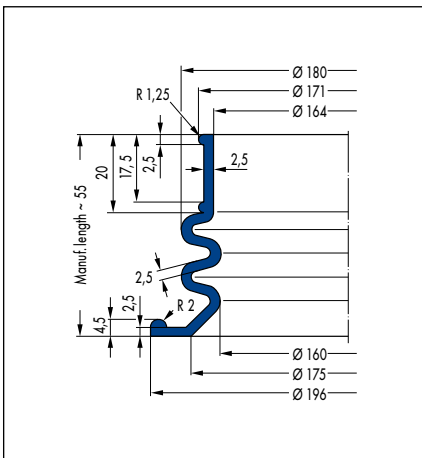

V6-01234, Article No. 501406

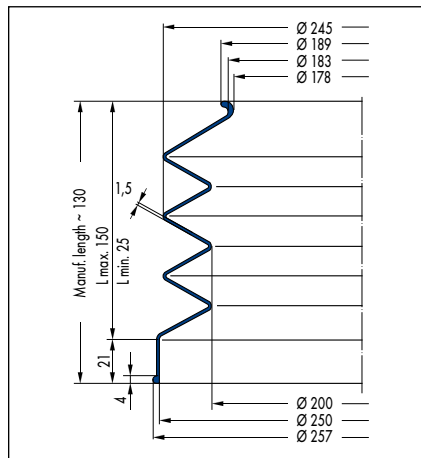

V6-00782, Article No. 7509

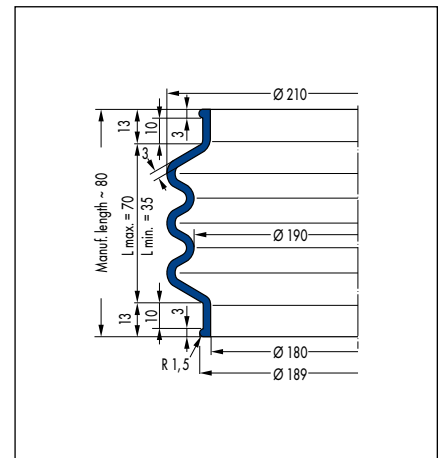

V6-00661, Article No. 29824 (45 NBR 670)/  
60028128 (50 CR 879)

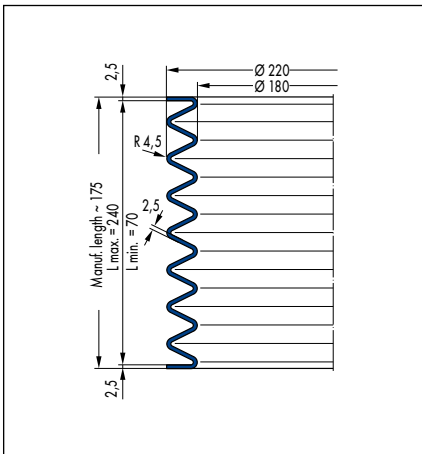

V6-00345, Article No. 325185 (CR)/  
29554 (NBR)

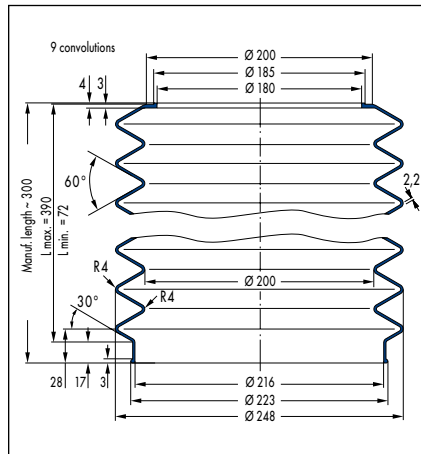

V6-01474, Article No. 49365010

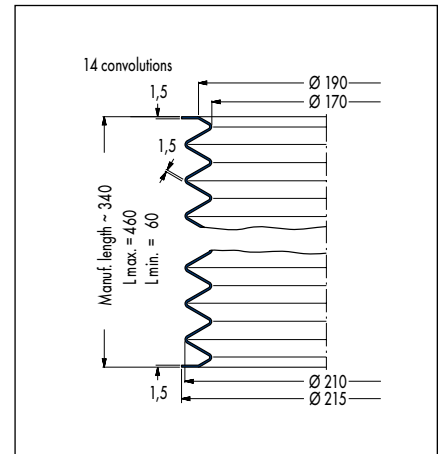

V6-00767, Article No. 36413

